

Anbauanleitung Multi Mount Frontaufnahme Isuzu D-max ab Bj. 2012

*Installation instruction multi mount kit
Isuzu D-max from 2012 on*

Best.-Nr.: 1 -25906

AL: 2022 – 01



**Hier sehen sie die fertig montierte Frontaufnahme.
Bevor sie mit der Montage beginnen, lesen sie bitte diese Anleitung
und die Bedienungsanleitung der Seilwinde gut durch.**

Achtung:

Bei Fahrten im öffentlichen Straßenverkehr muß die Aufnahme mit der Kunststoffabdeckung Best.nr.: **1 - 37509** abgedeckt werden.

*Here you see the ready mounted multi mount kit.
Before you start the assembly, please read and understand this manual
and the manual of the winch.*

Stückliste Multi Mount Frontaufnahme Isuzu D-max ab Bj.2012
Partlist snowplow multi mount kit Isuzu D-max from 2012 on
Best.nr.: 1 - 25906

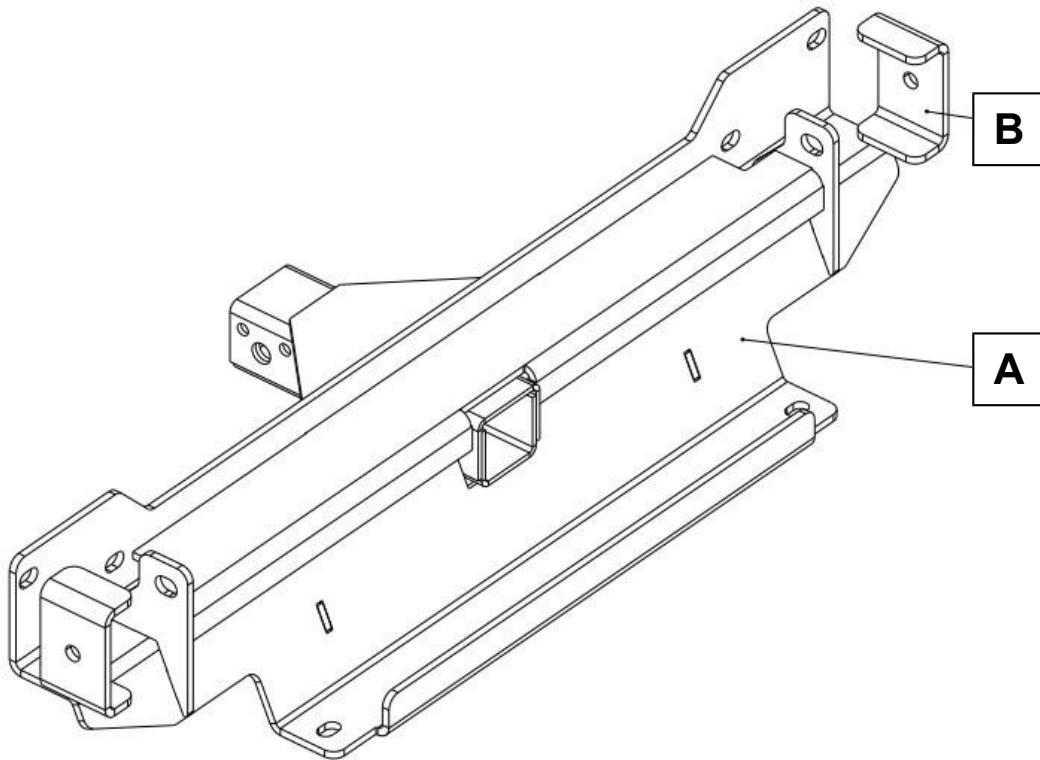

| | |
|---------------------------------|-------------------------------|
| 1 x Frontaufnahme (A) | 6 x Schraube M 10 x 1,25 x 30 |
| 2 x Verstärkungswinkel (B) | 2 x Schraube M 10 x 80 |
| 1 x Kunststoffabdeckung 1-37509 | 10 x U-Scheibe M 10 x 30 x 3 |
| 1 x Anbauanleitung AL 20 22 | 8 x Federring M 10 |
| 1 x Gutachten | 2 x Mutter M 10 |
| 1 x Kennzeichnungsaufkleber | 2 x Schraube M 6 x 20 |
| | 2 x U-Scheibe M 6 x 20 |
| | 2 x Federring M 6 |



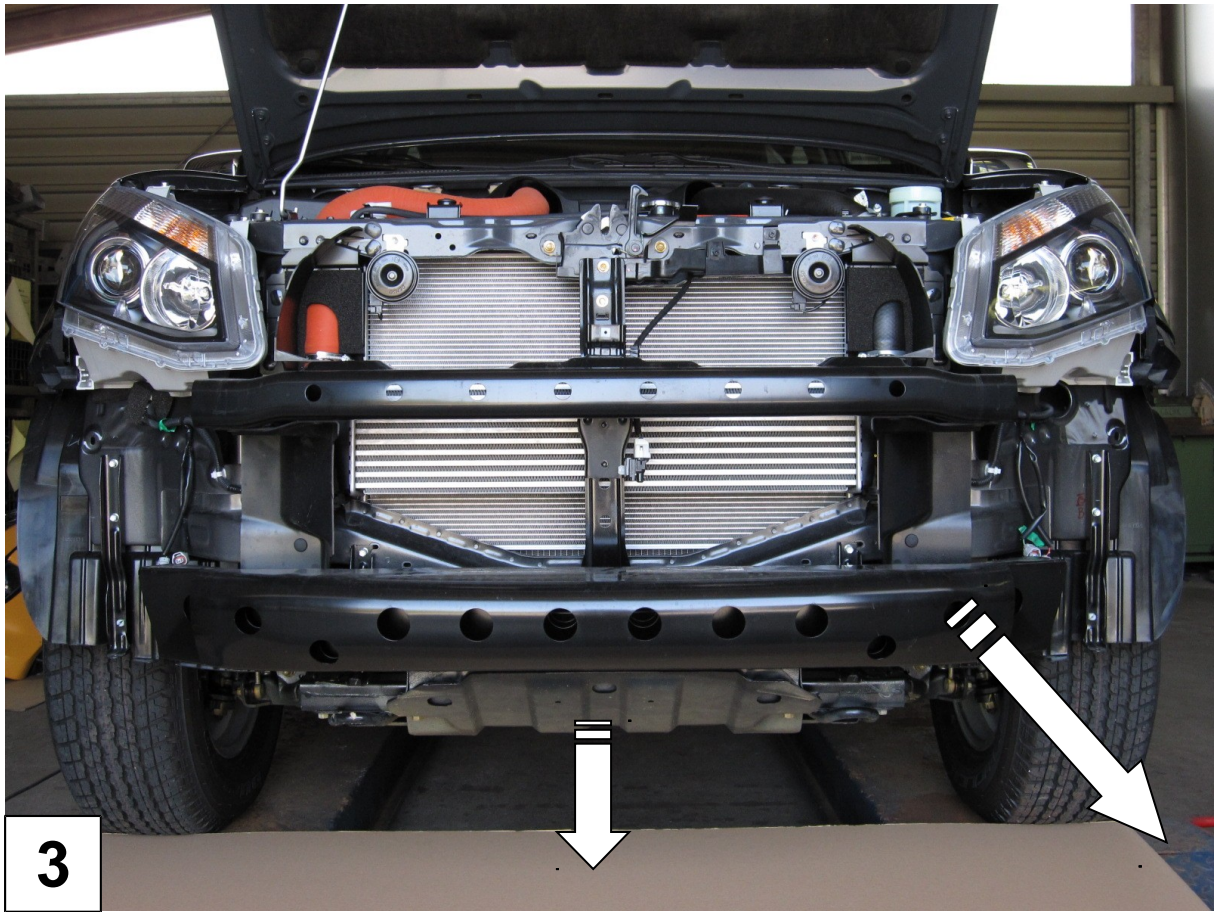

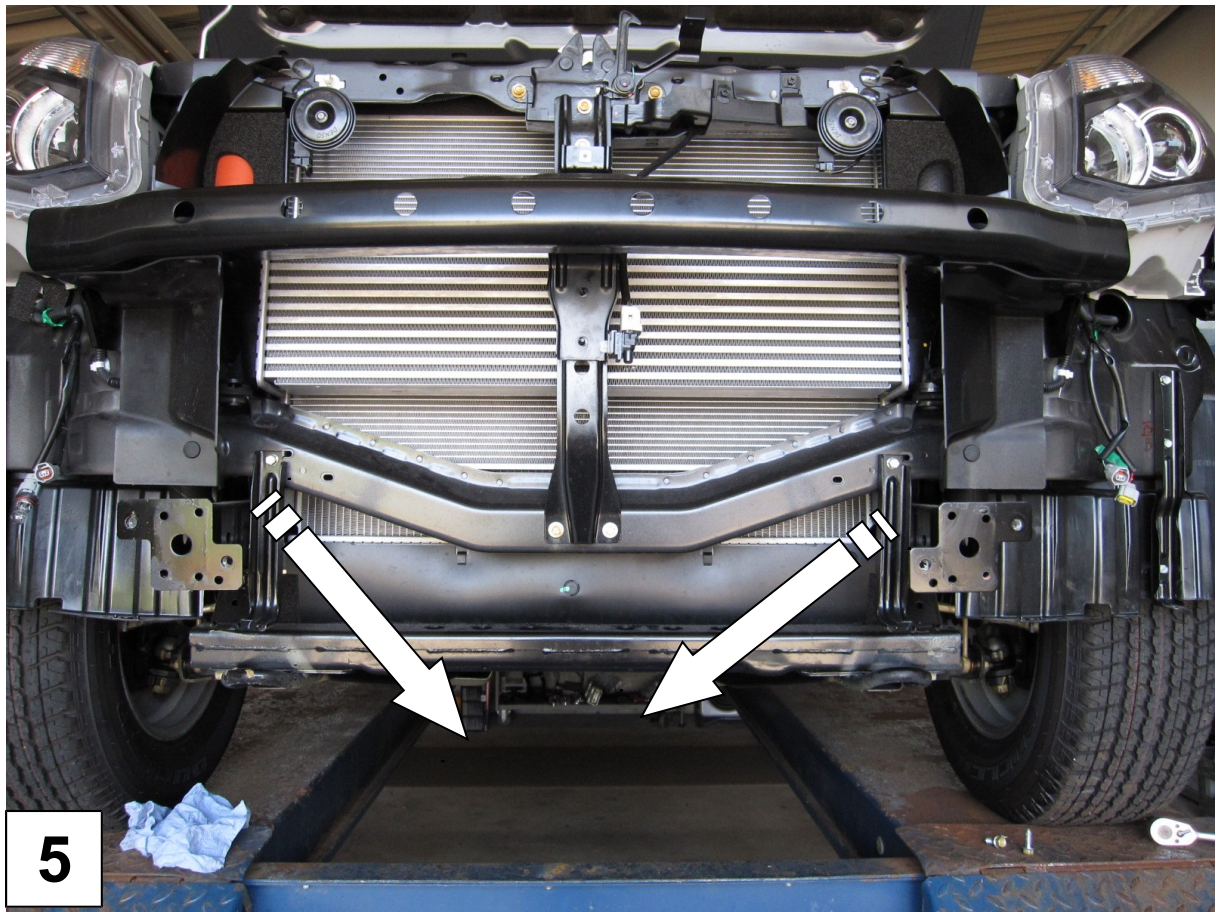

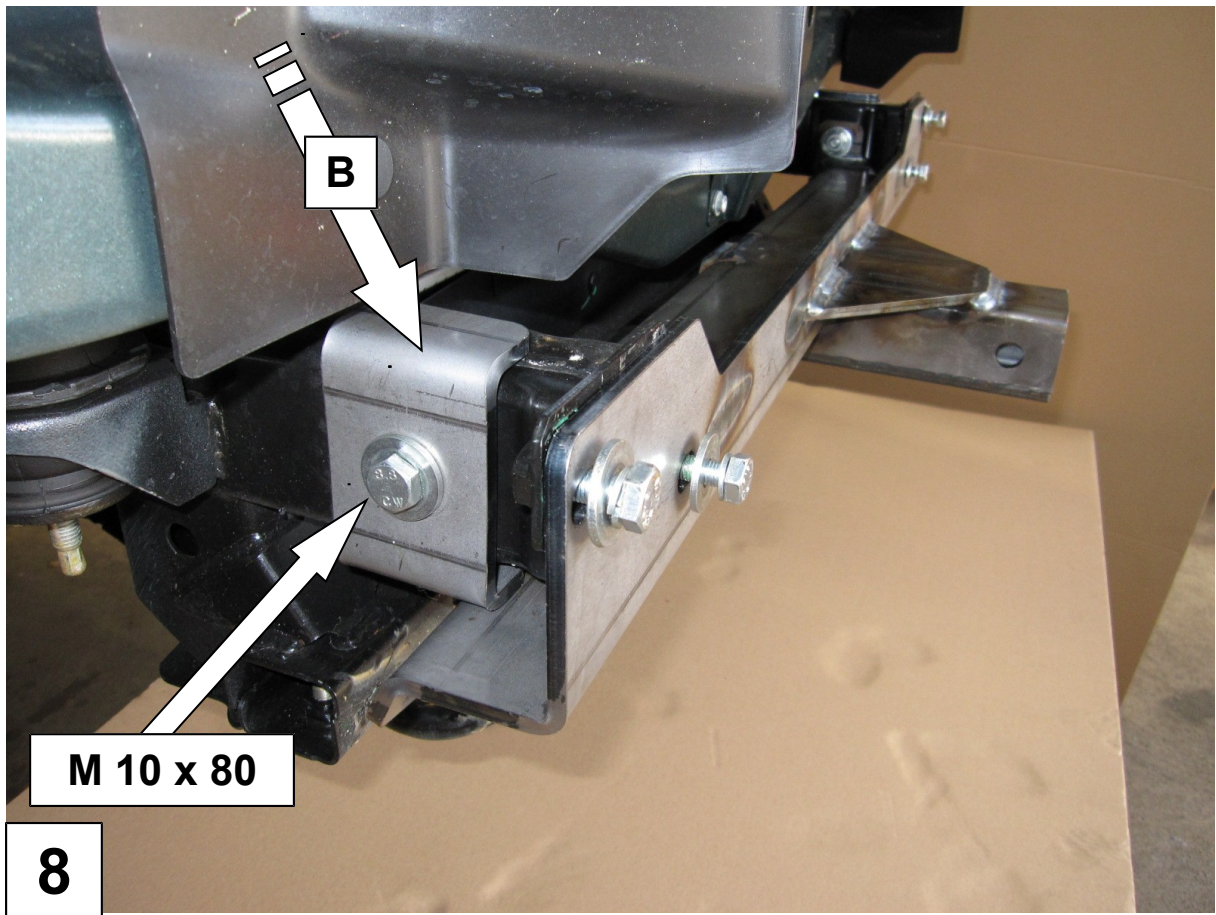
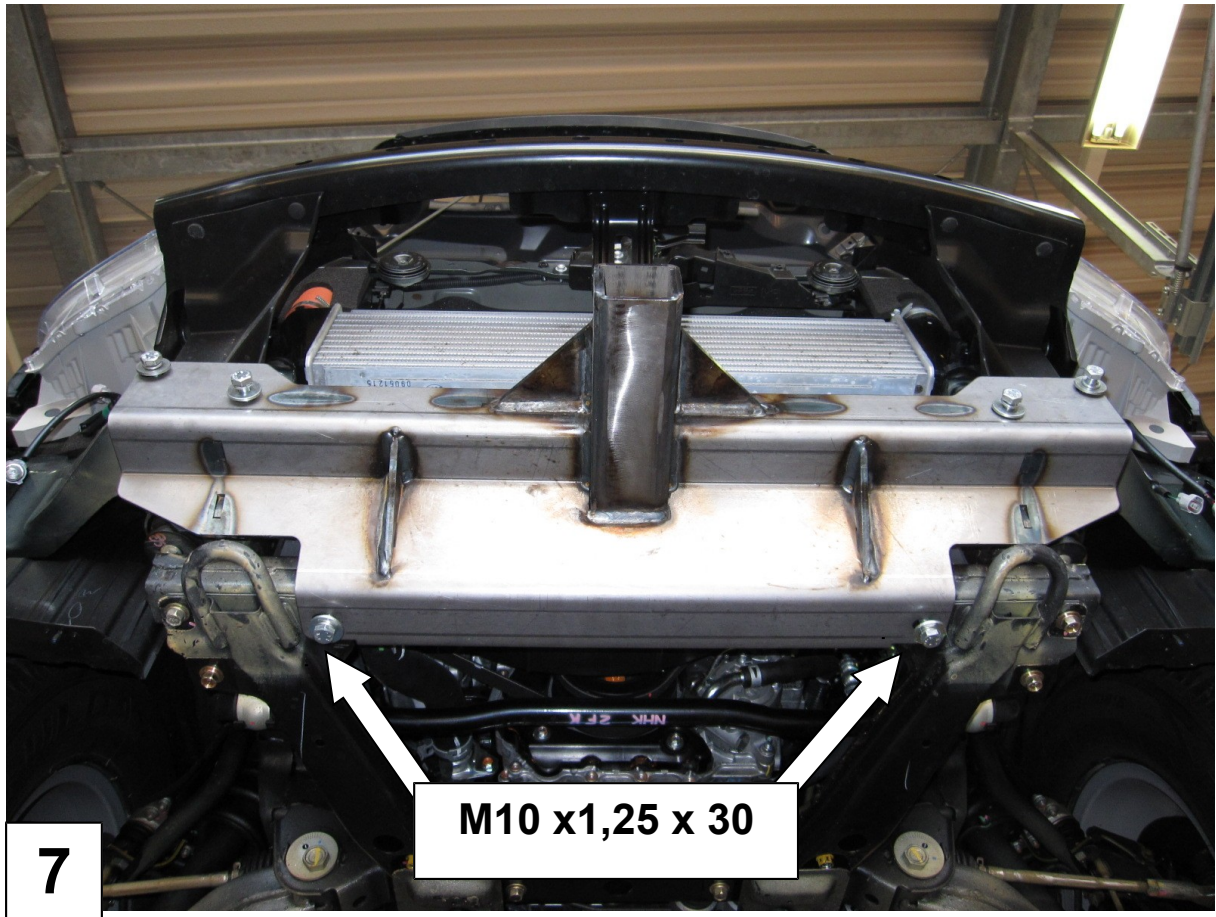

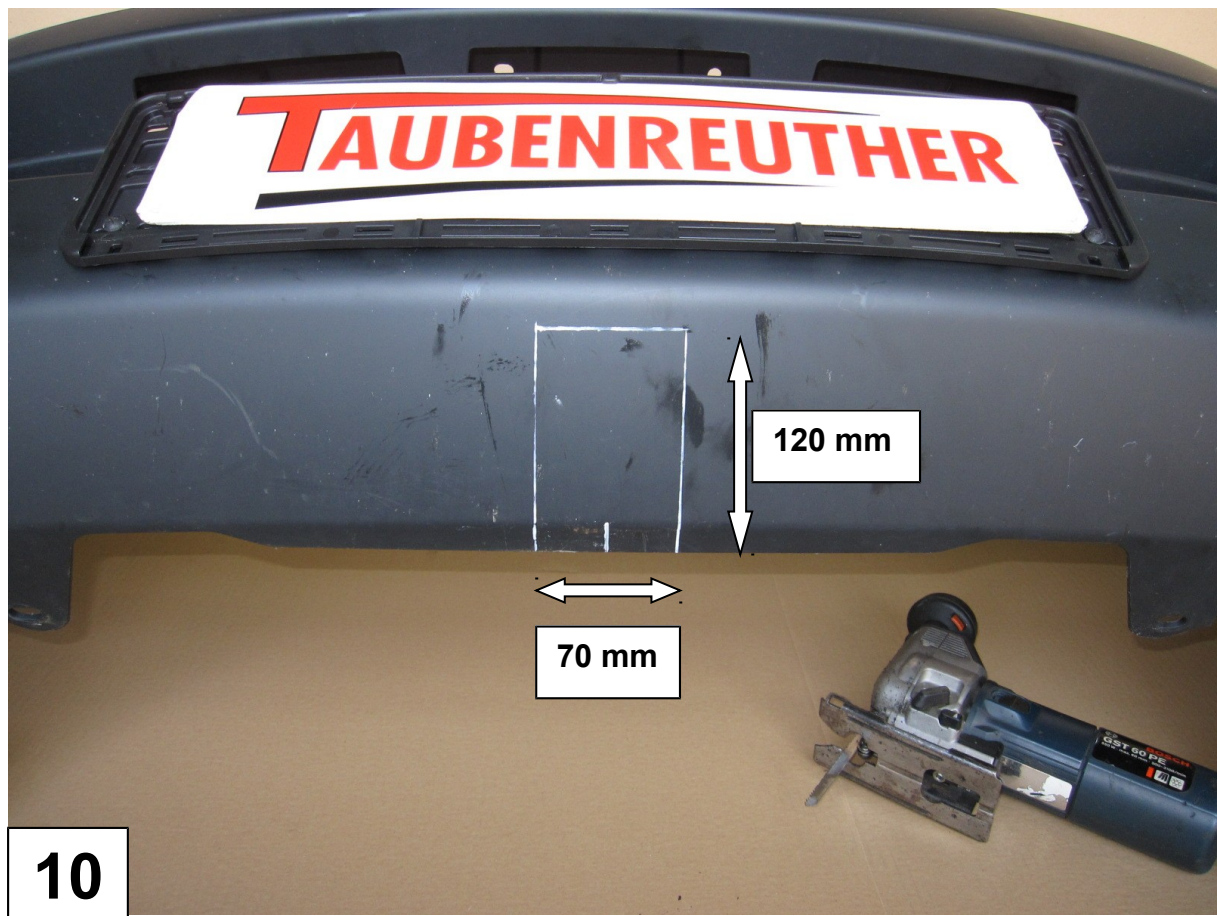
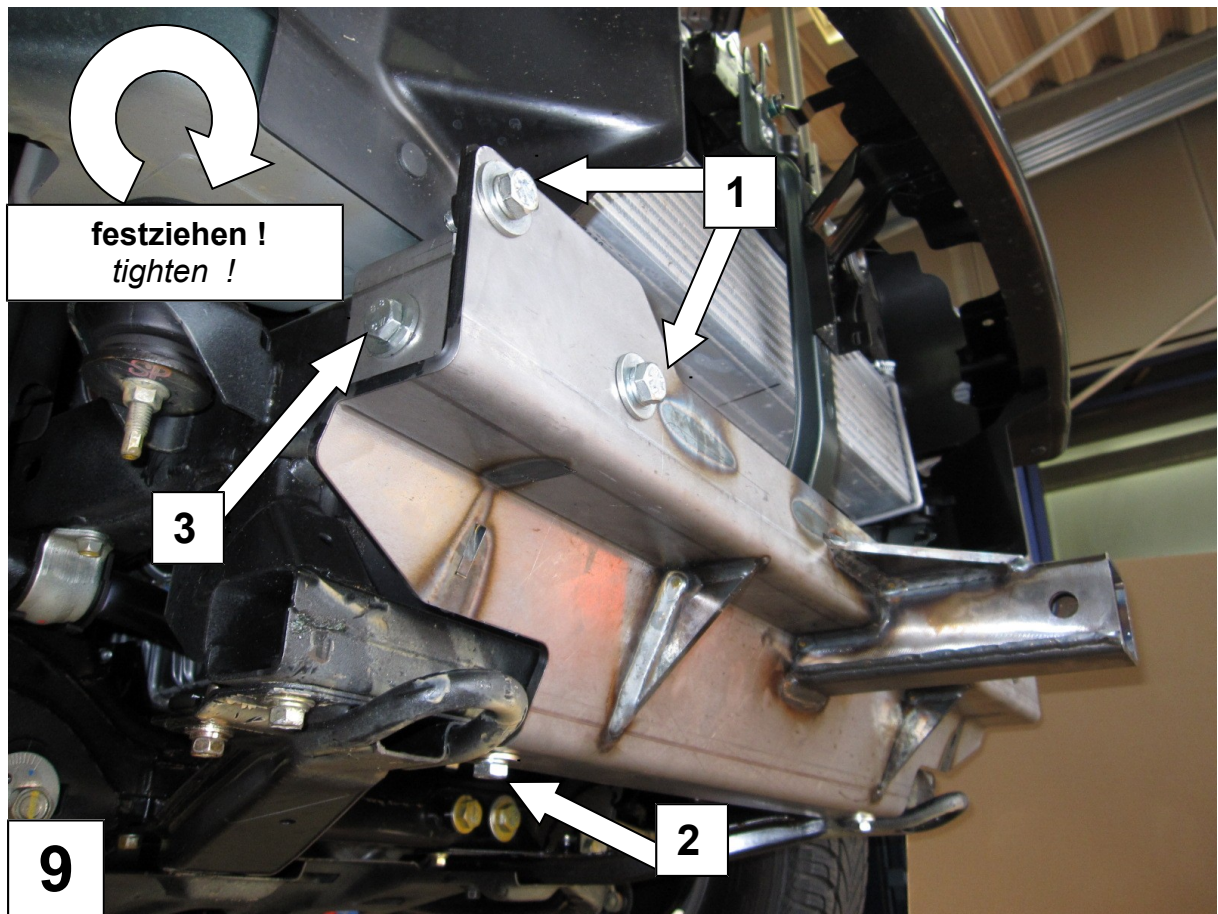

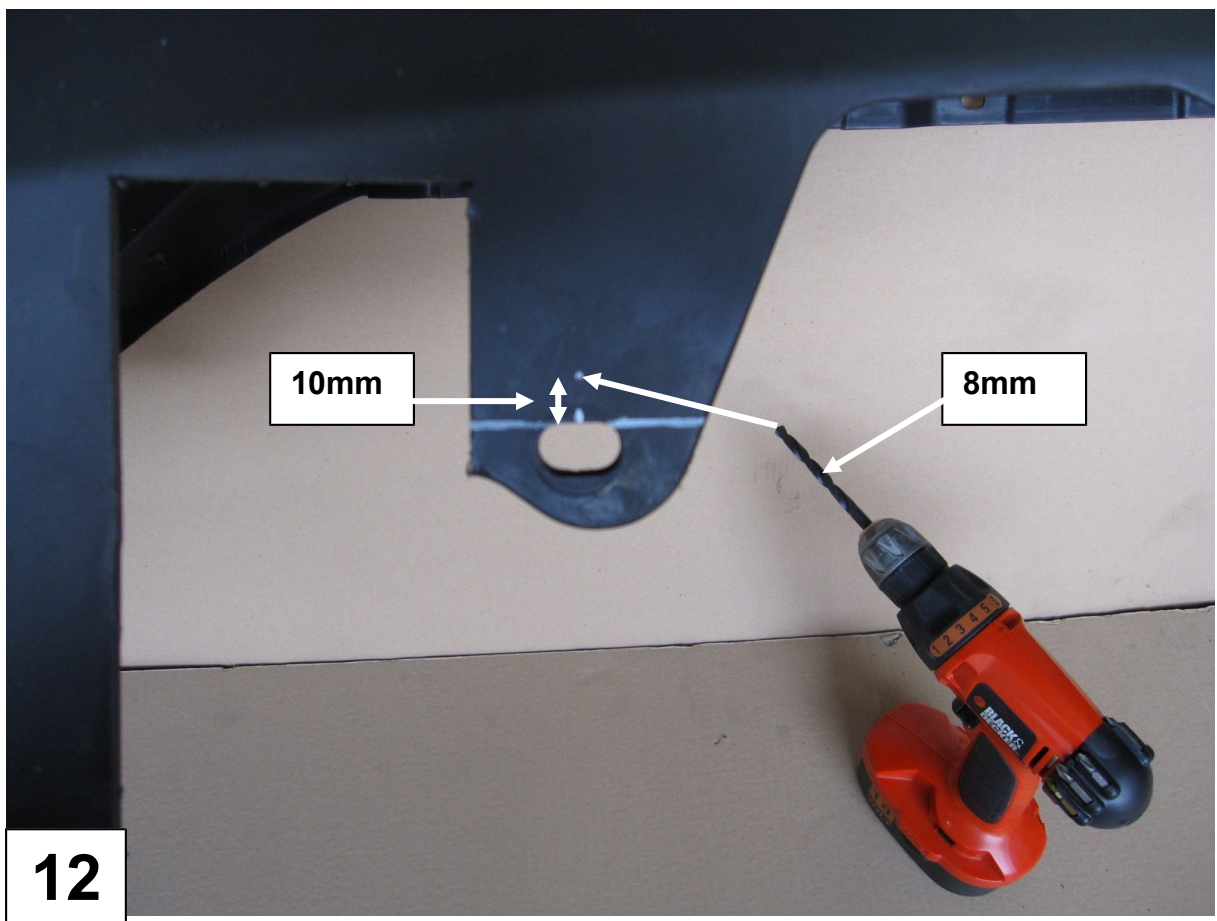

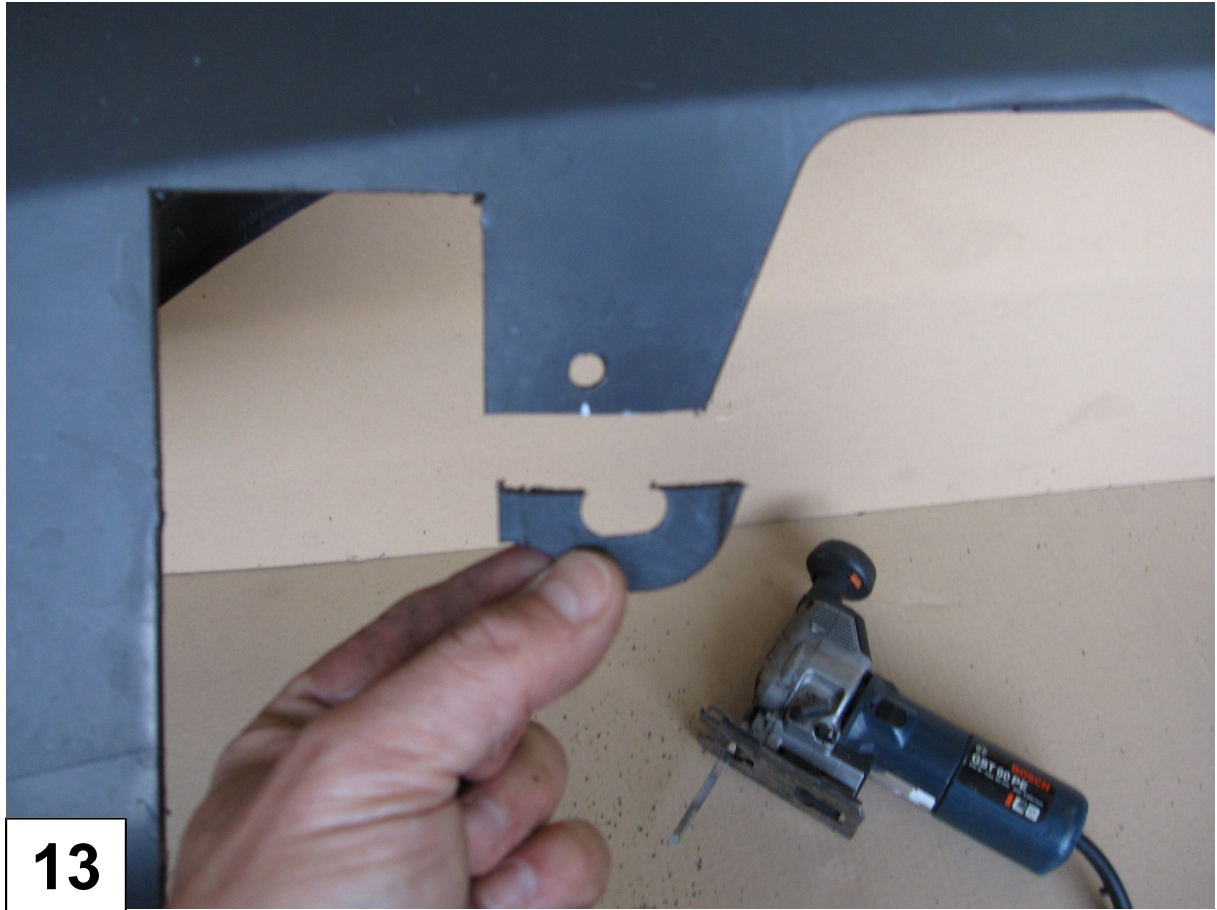

13



14

