

## Anbauanleitung Seilwindenanbausatz Mitsubishi Pajero V60 und V80

Best.-Nr.: 16 -3840

AL: 1080 – 08



**Hier sehen sie den fertig montierten Seilwindenanbausatz.  
Bevor sie mit der Montage beginnen, lesen sie bitte diese Anleitung  
und das Benutzerhandbuch der Seilwinde gut durch.**

**Achtung:**

Bei Fahrten im öffentlichen Straßenverkehr muß das Rollenseilfenster mit einer Kunststoffabdeckung abgedeckt werden.

# Stückliste

## Seilwindenanbausatz Mitsubishi Pajero V 60 und V80

Best.nr.: 16 – 3840 bzw. Z 4245384

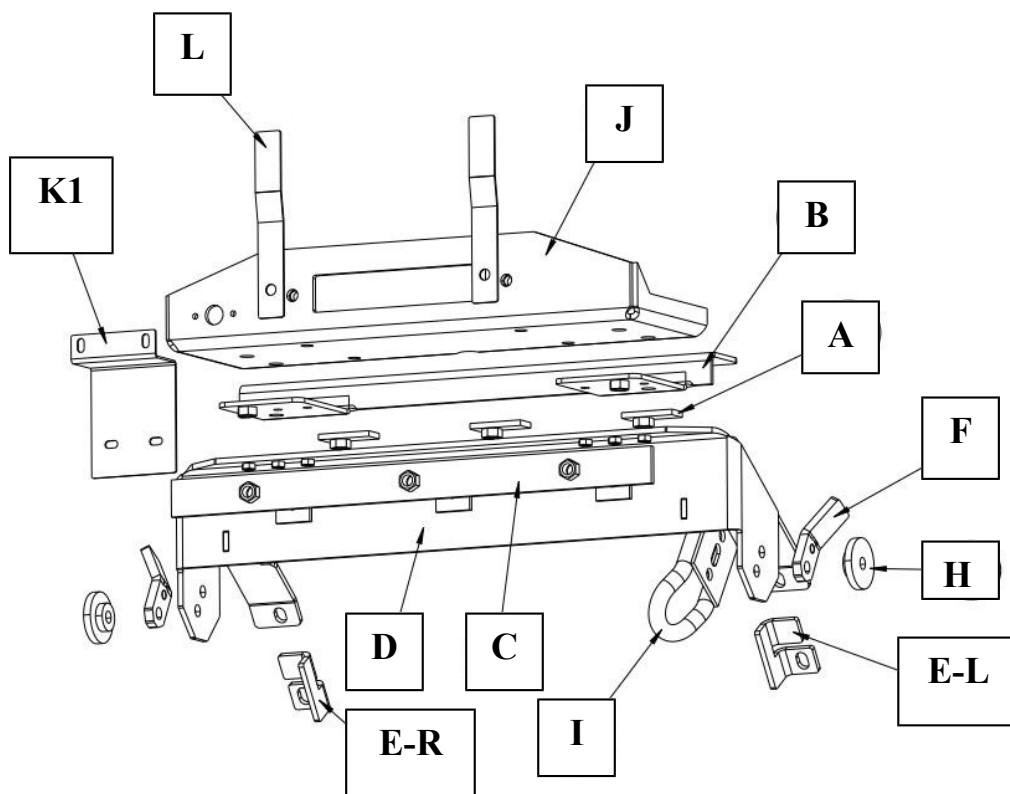

3 x Gewindeplatte ( A )  
1 x Grundträger hinten ( B )  
1 x Flacheisen mit Gewinde ( C )  
1 x Grundträger vorne ( D )  
1 x Distanzplatte für Stabilisator ( E-R )  
1 x Distanzplatte für Stabilisator ( E-L )  
2 x Gewindeplatte ( F )

2 x Scheibe abgedreht ( H )

1 x Abschleppöse ( I )  
1 x Seilwindenkassette ( J )

1 x Schaltkastenhalter V 60 ( K 1 )  
2 x Kennzeichenhalter ( L )

1 x Kabelsatz 16 – 387 K  
1 x Steckdose 1-90394 ( M )

1 x Gutachten  
1 x Anbauanleitung AL 1080

7 x Schraube M 12 x 30  
3 x Schraube M 12 x 40  
2 x Schraube M 12 x 60  
2 x Mutter M 12  
14 x U – Scheibe M 12  
12 x Federring M 12

1 x Schraube M 10 x 30  
3 x schraube M 10 x 25  
4 x Schraube M 10 x 1.25 x 40  
8 x U – Scheibe M 10  
8 x Federring M 10

6 x Senkkopfschraube M 8 x 20

2 x Schraube M 5 x 25  
2 x Mutter M 5  
4 x U – Scheibe M 5  
2 x Federring M 5

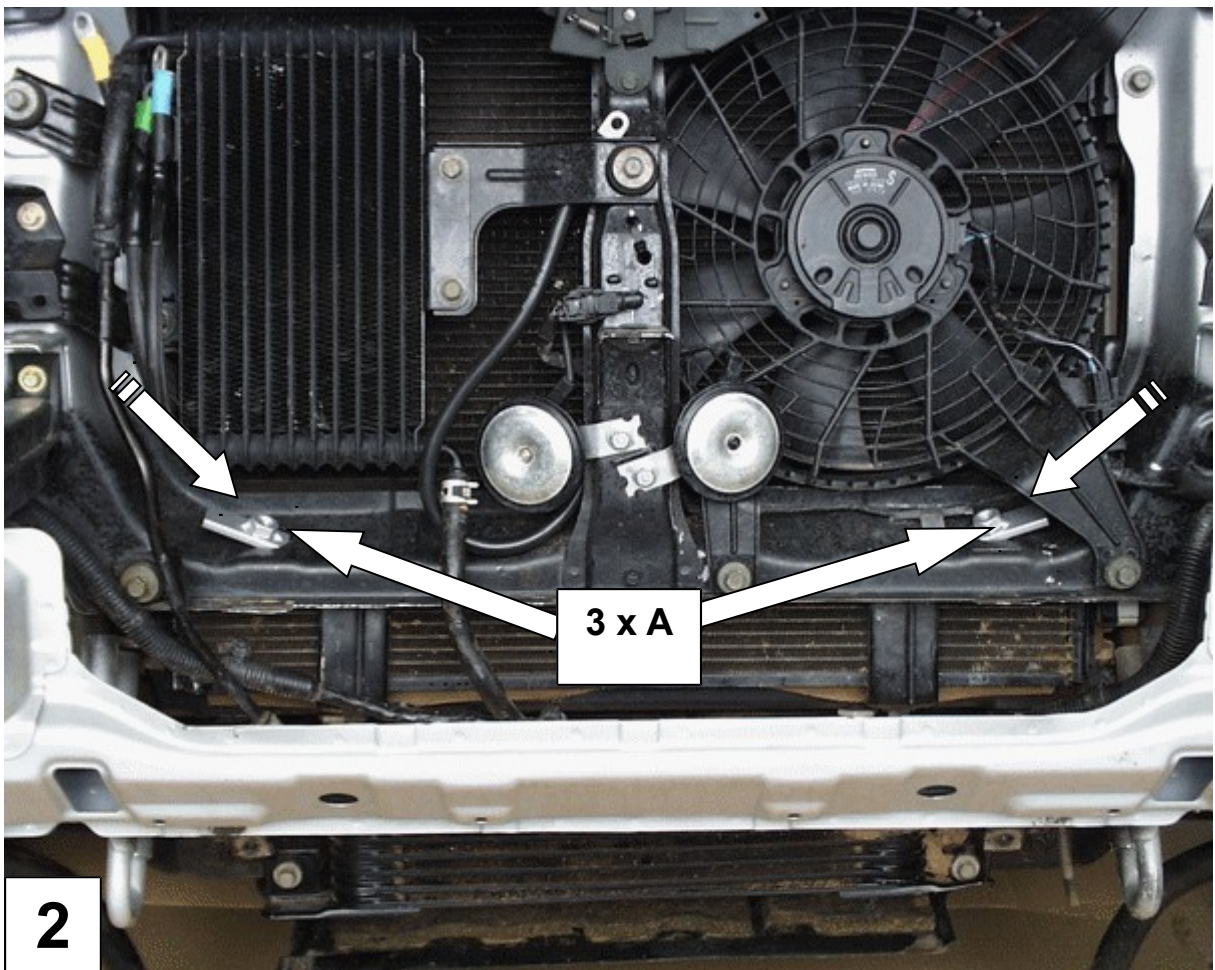

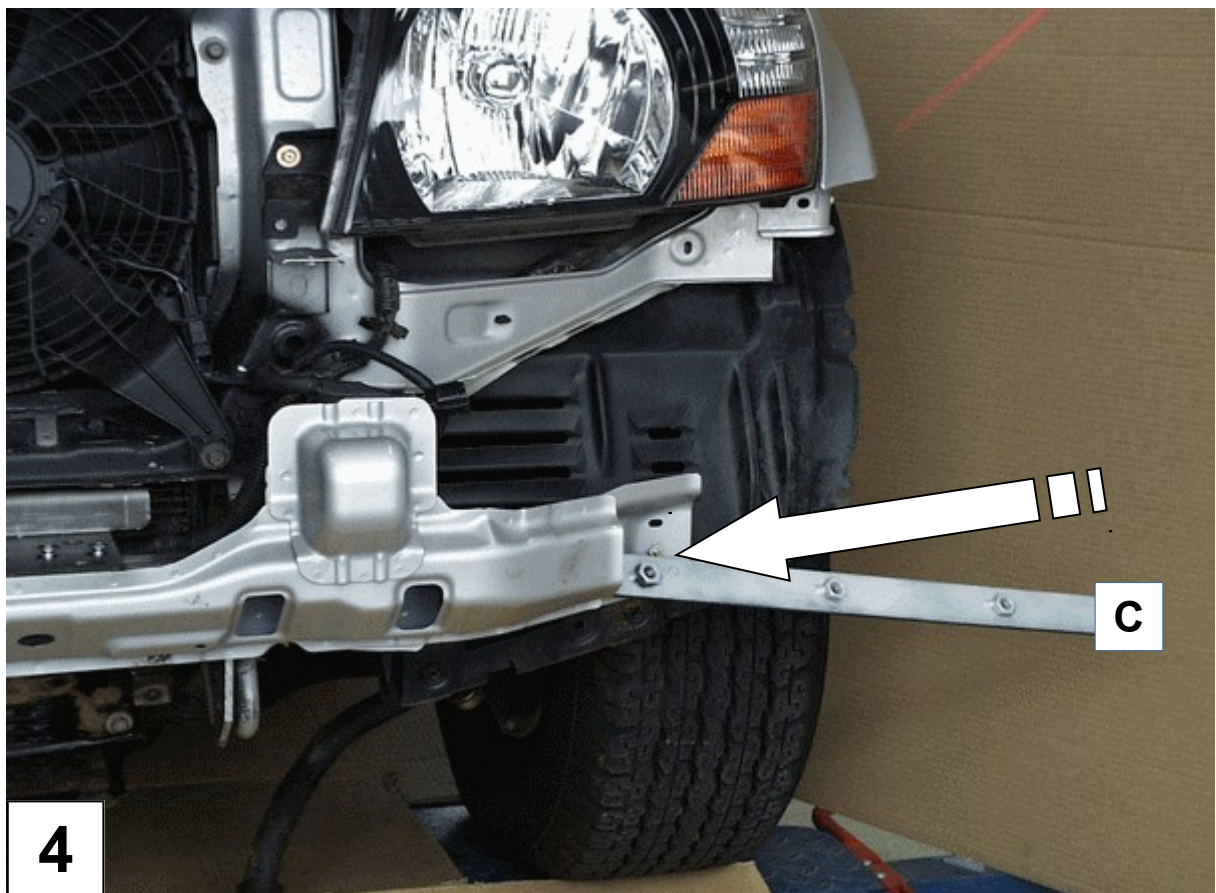
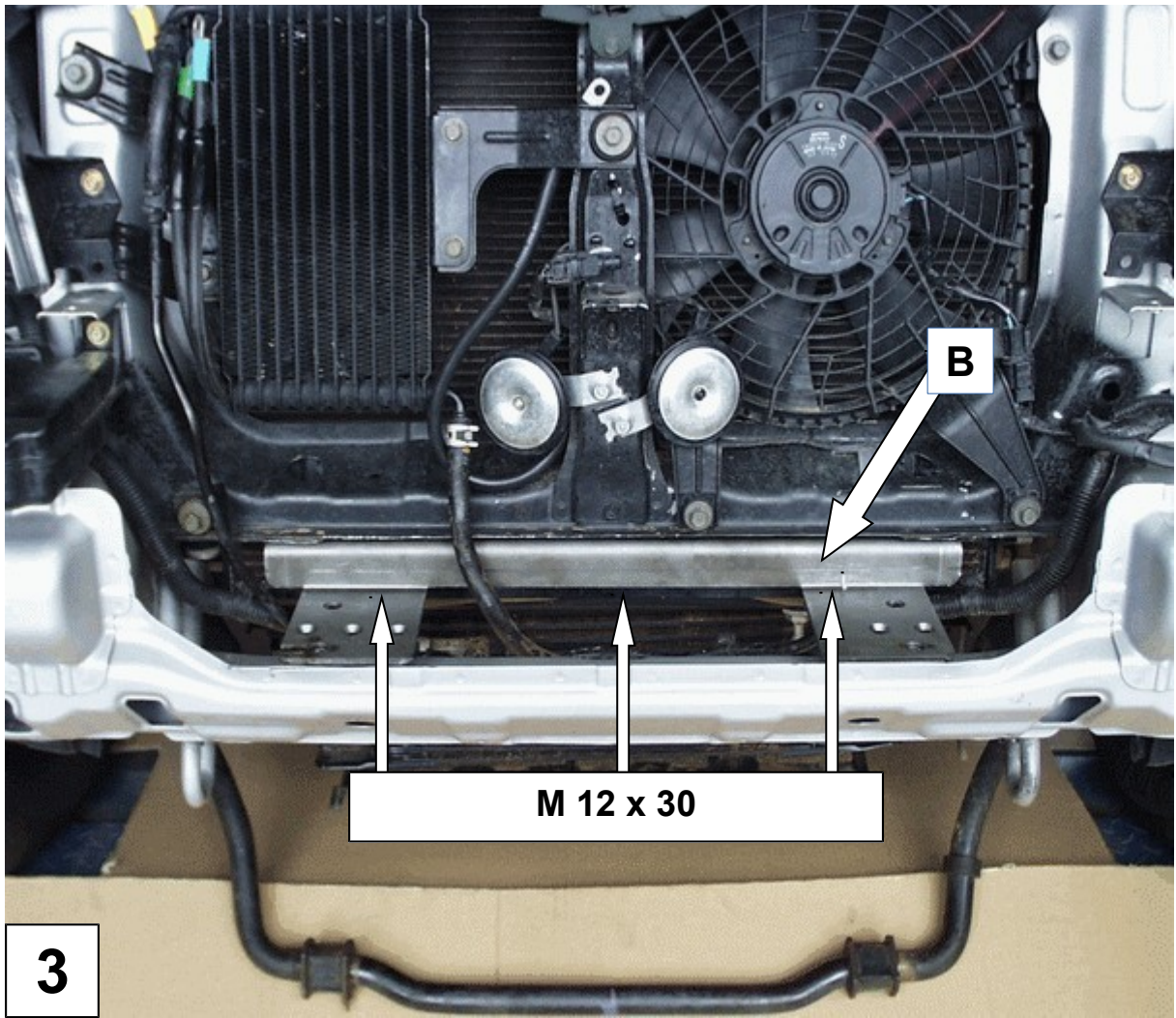

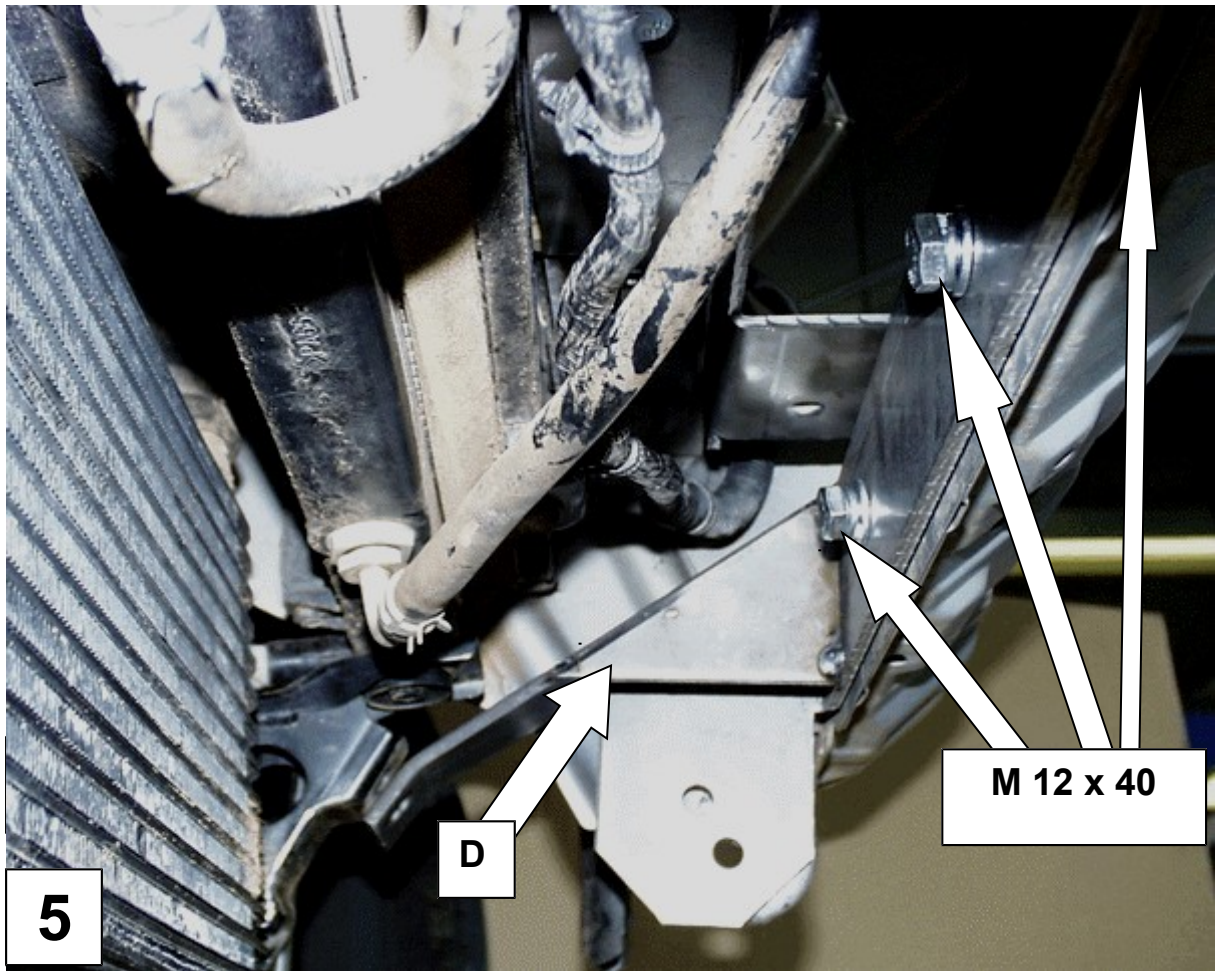

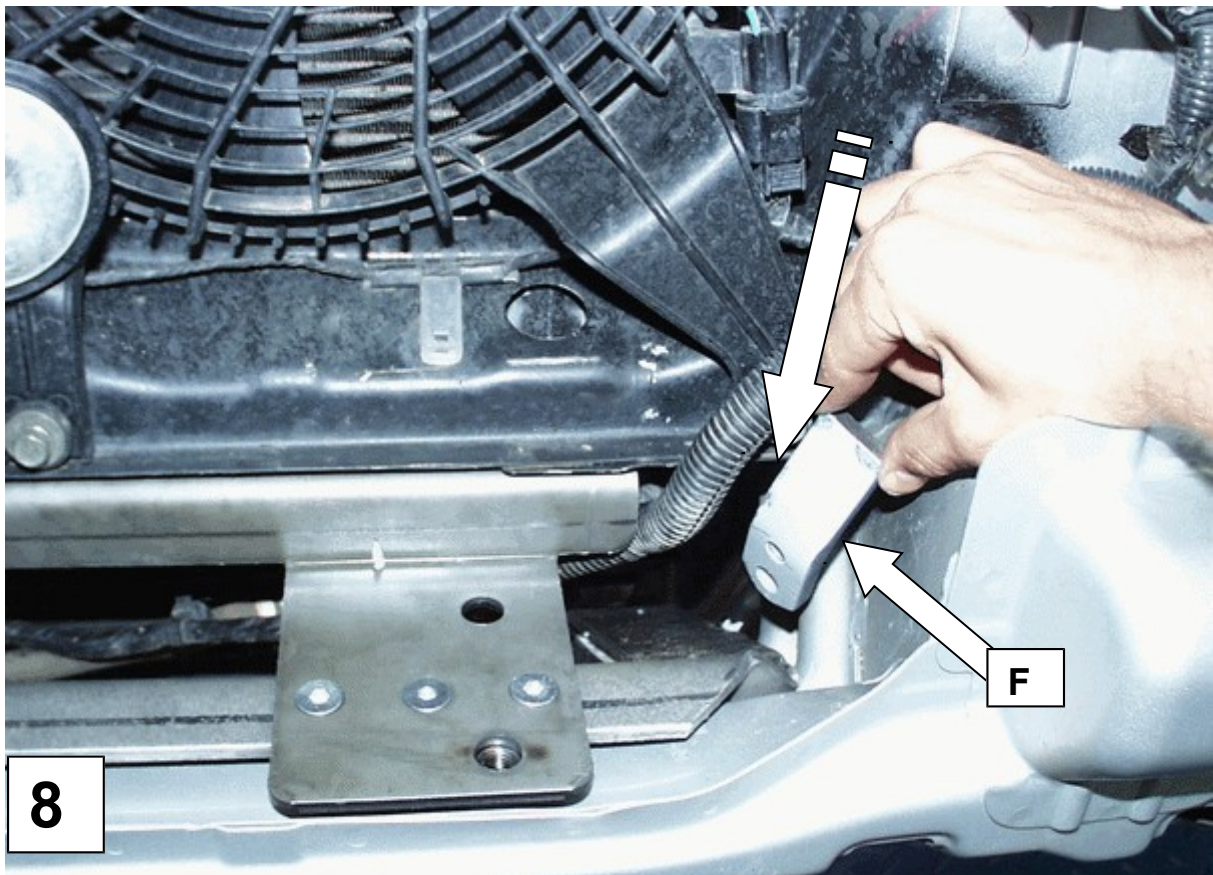
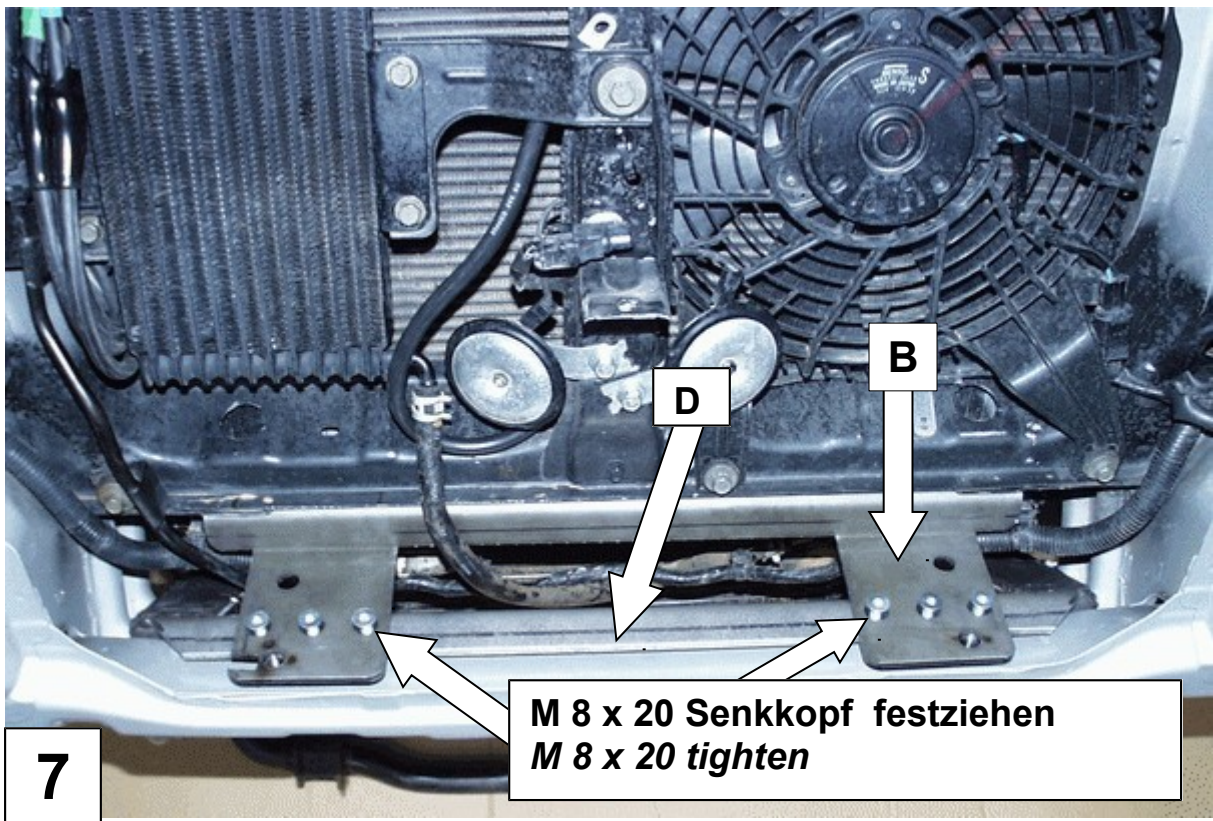

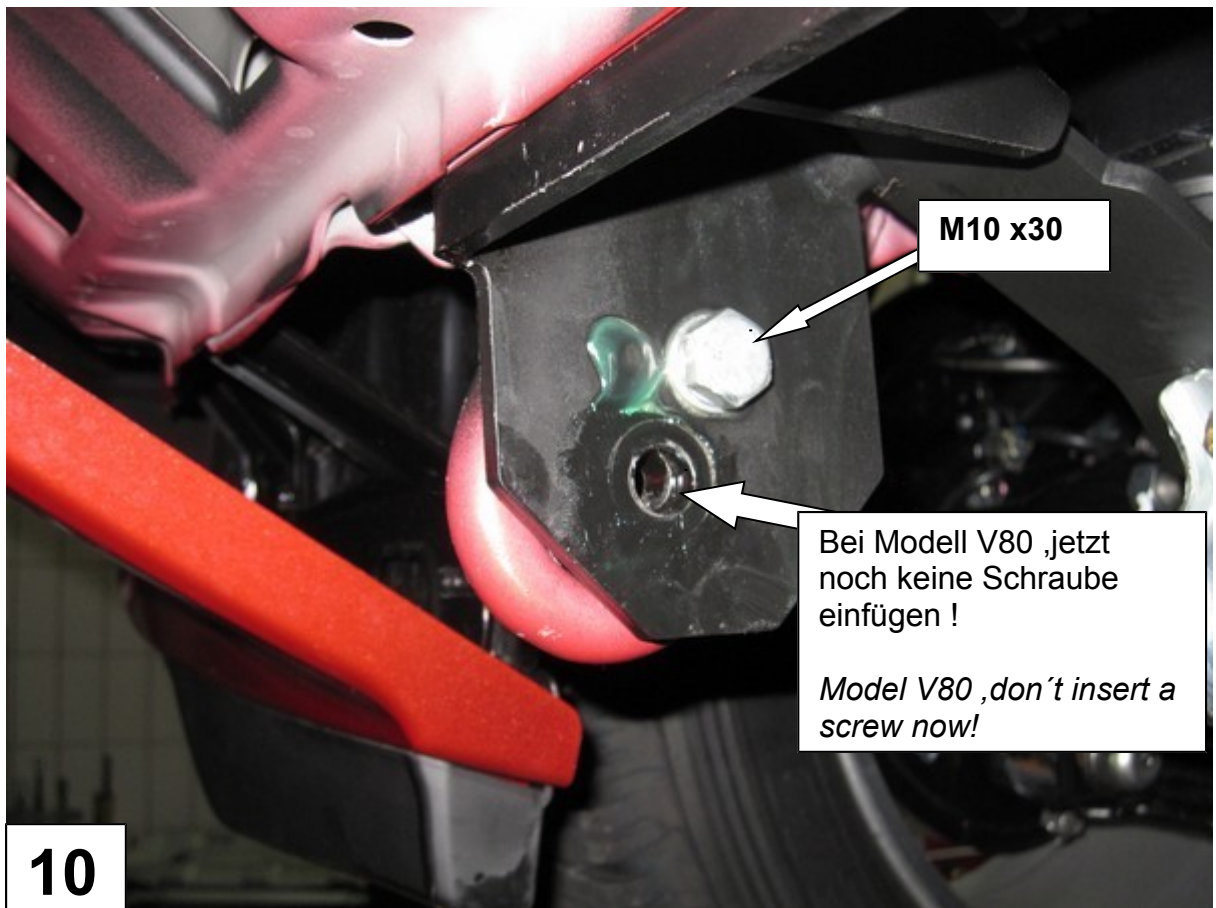
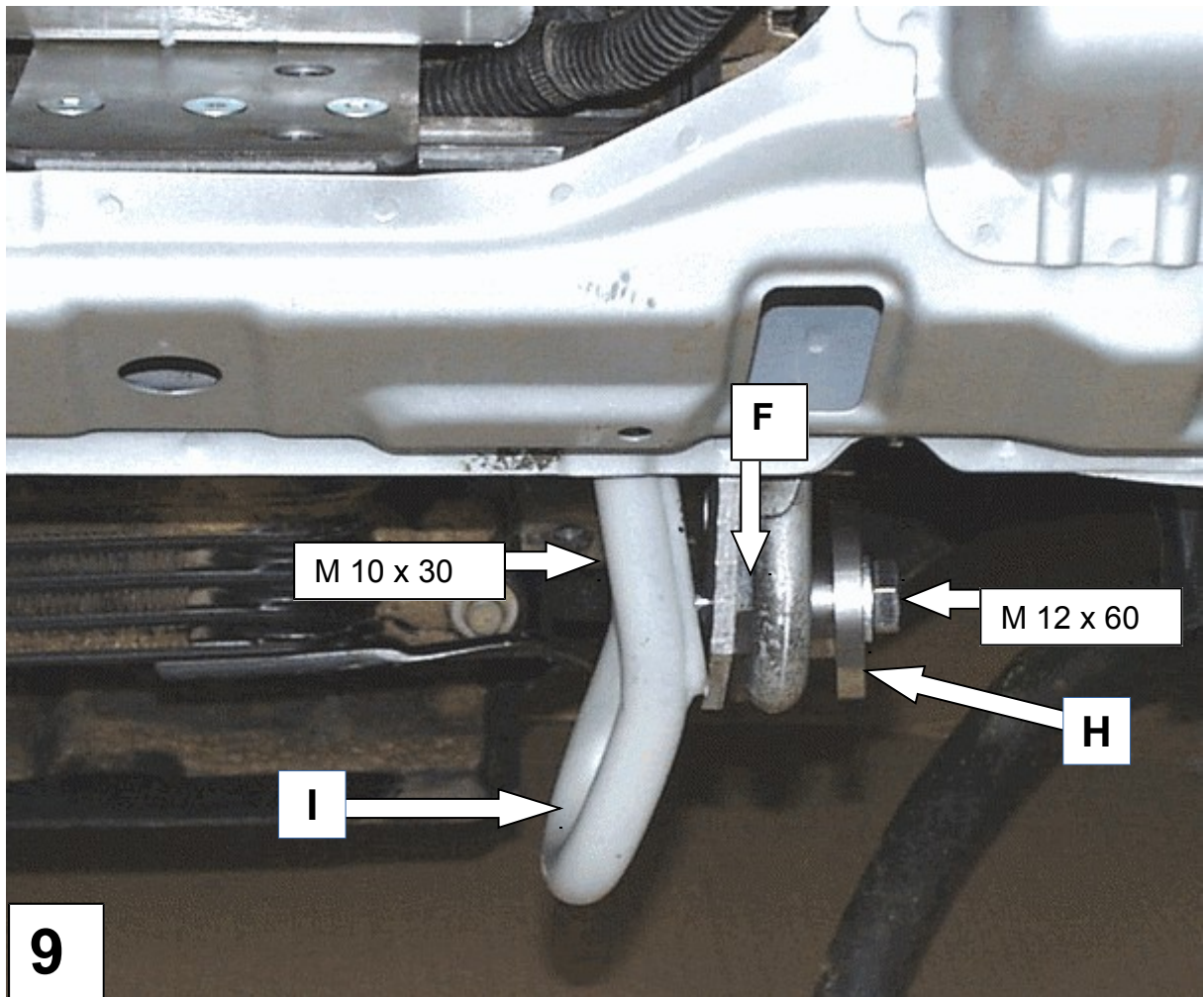

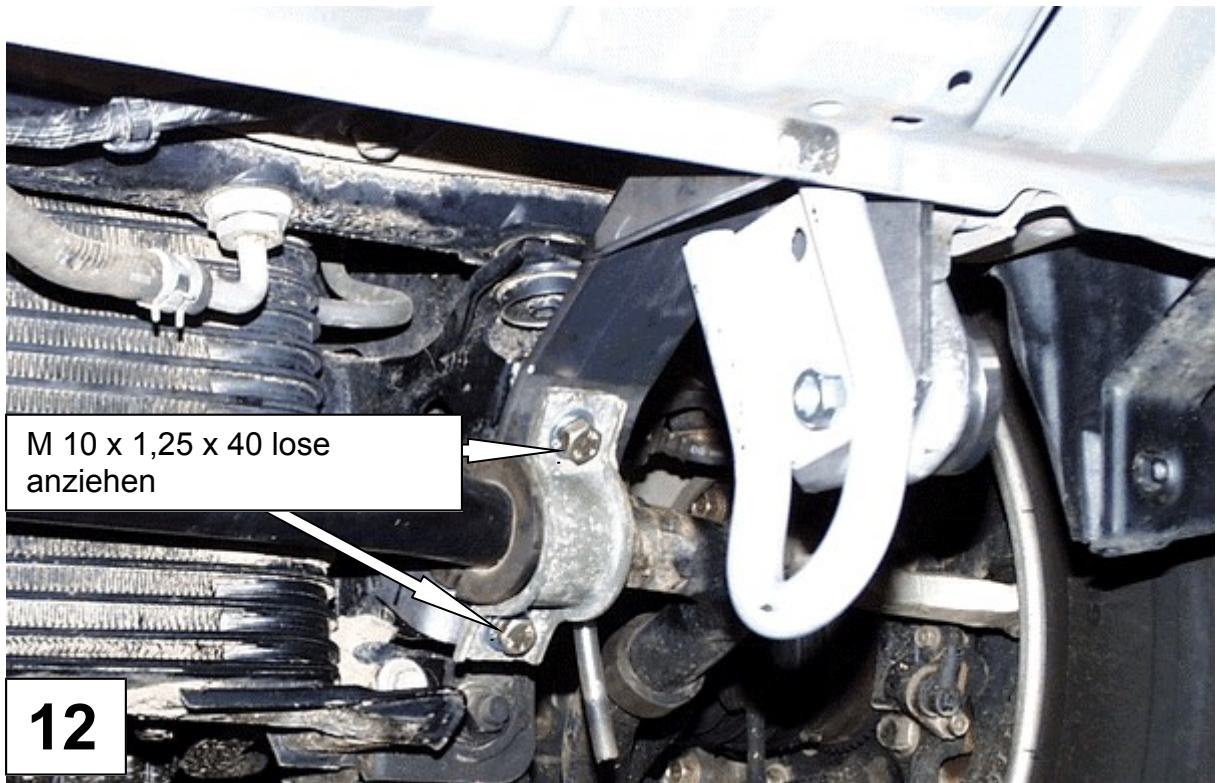
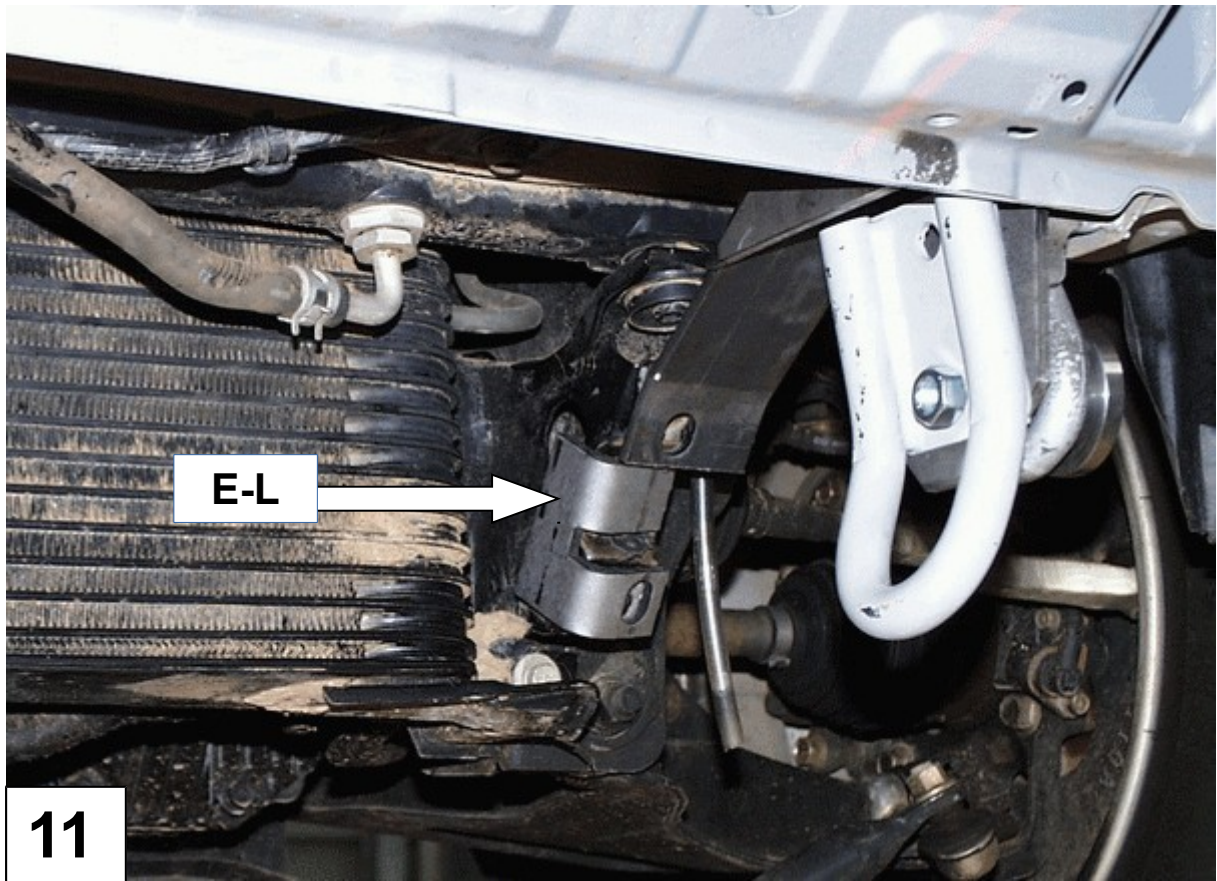



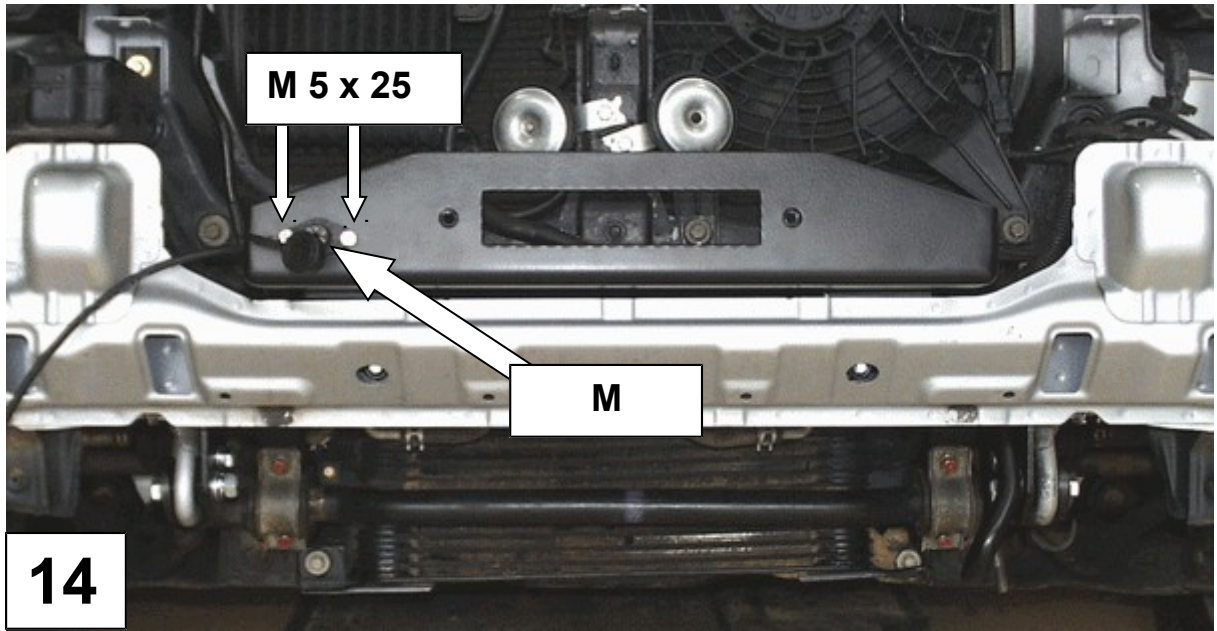
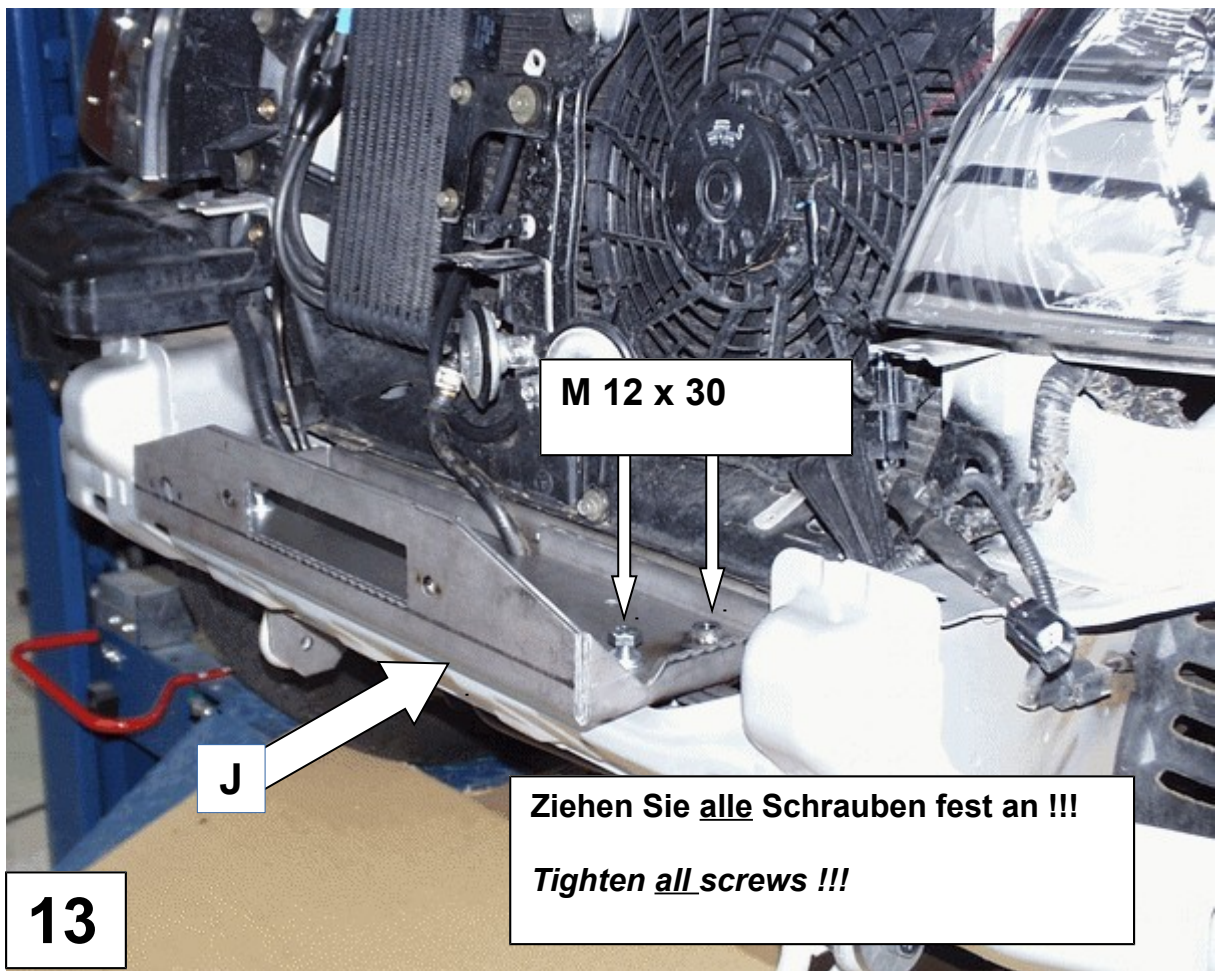

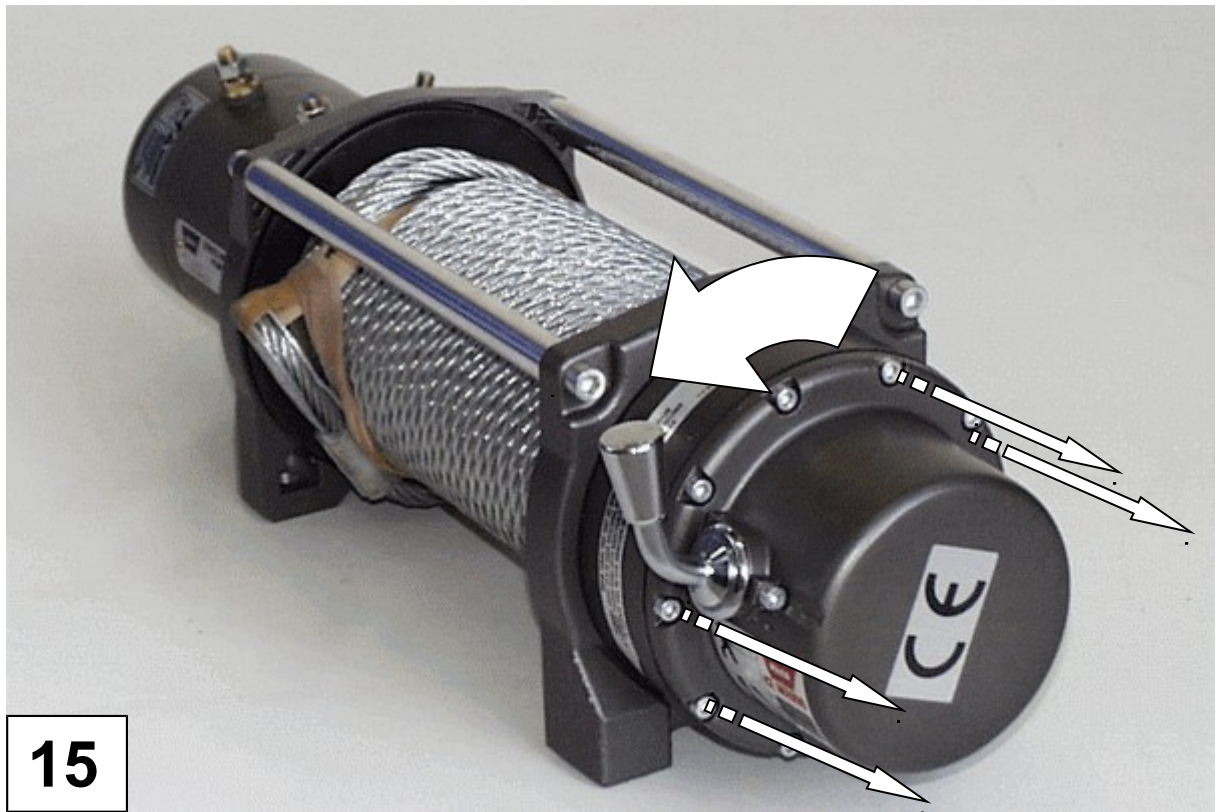

15

Punkt 16 bis 22 sind nur für V60 Modelle  
Step 16 to 22 is for V 60 models only

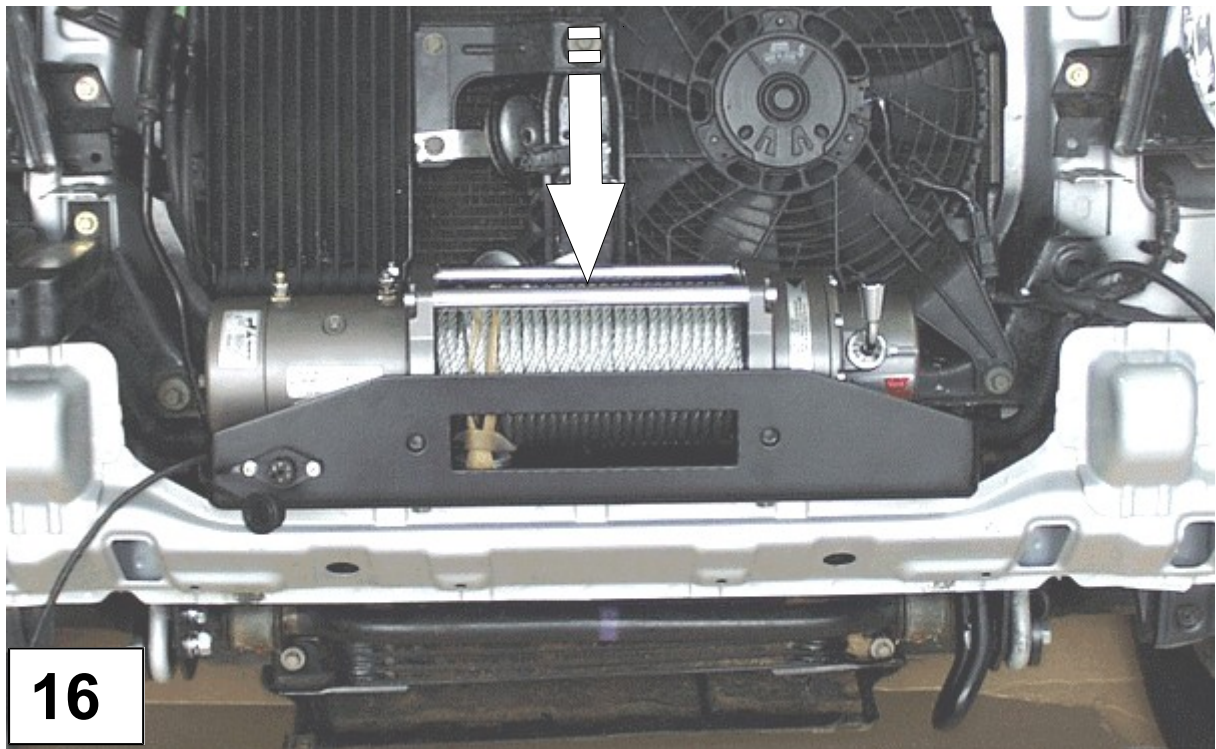

16

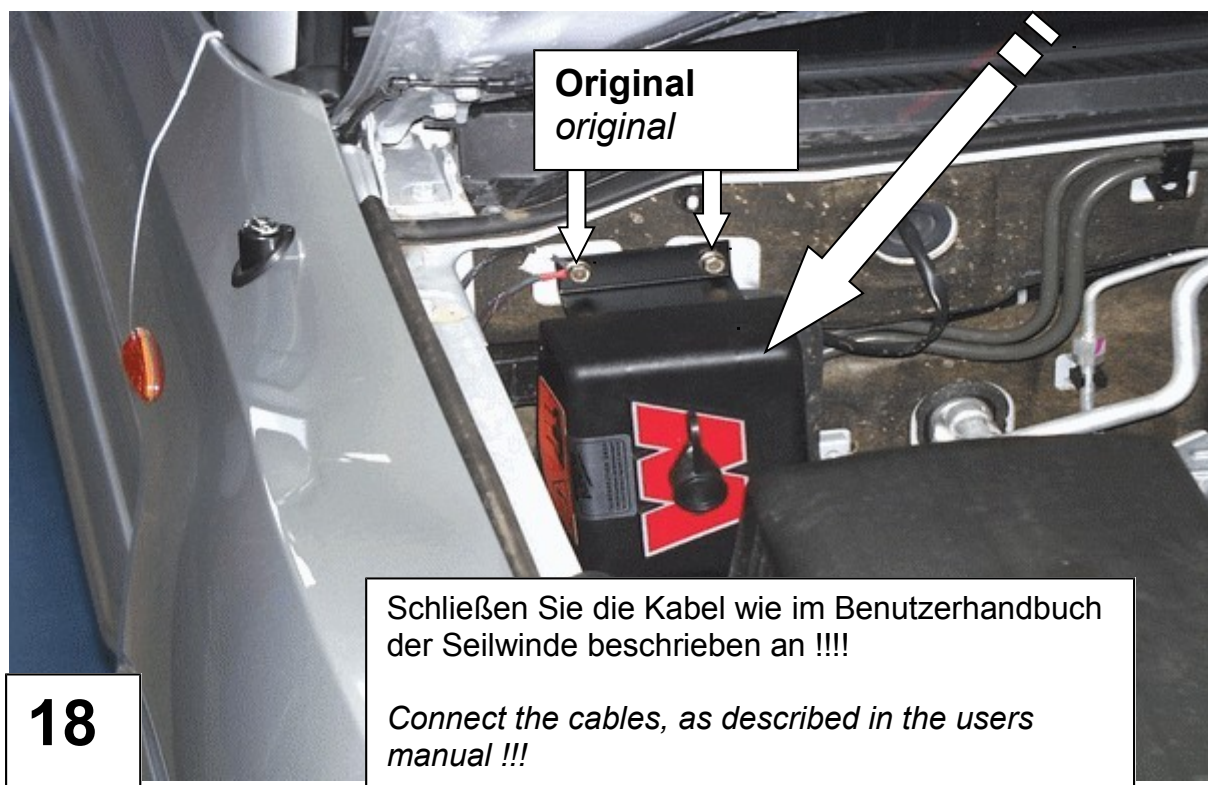
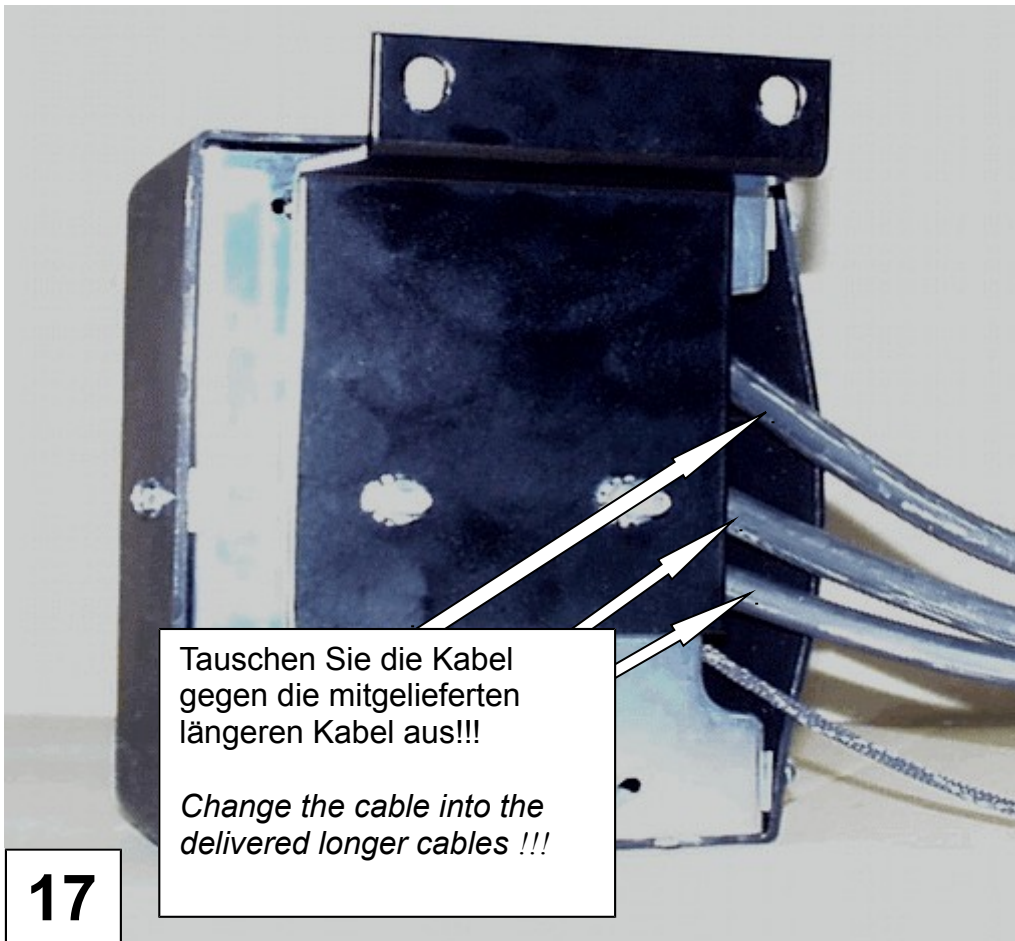

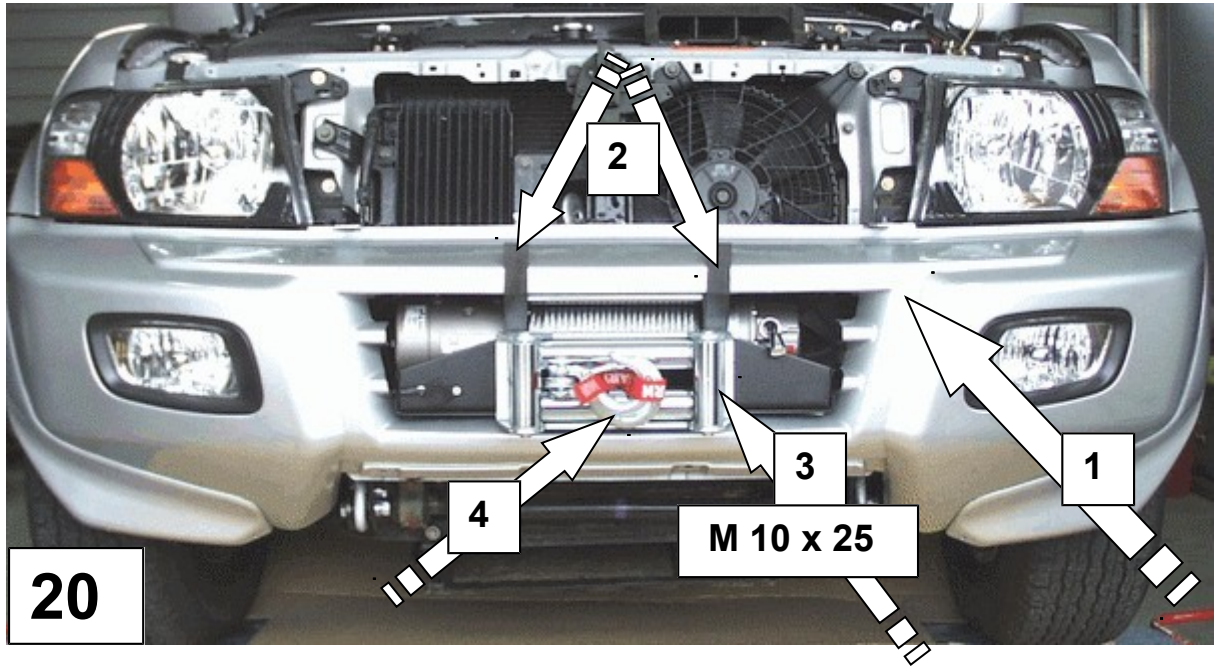
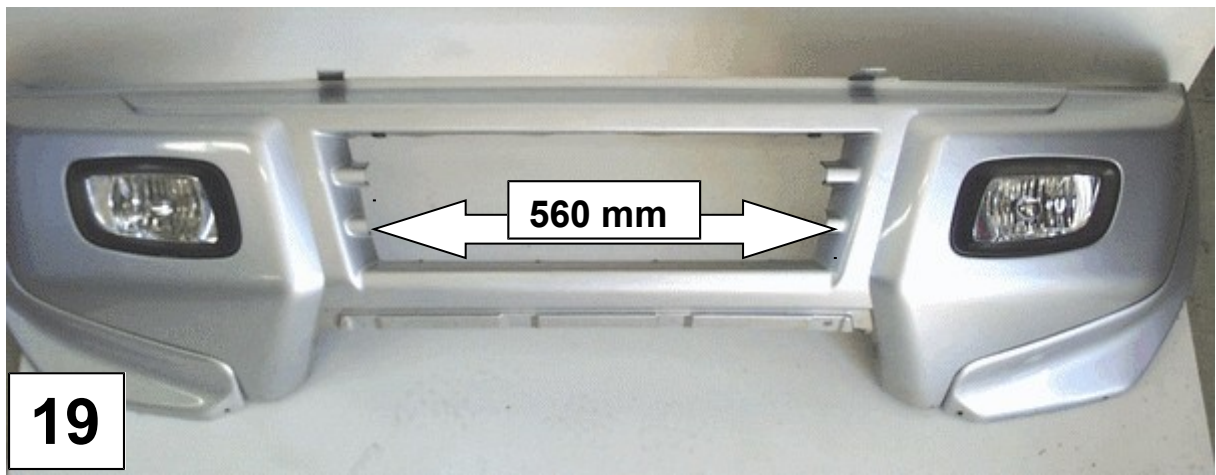

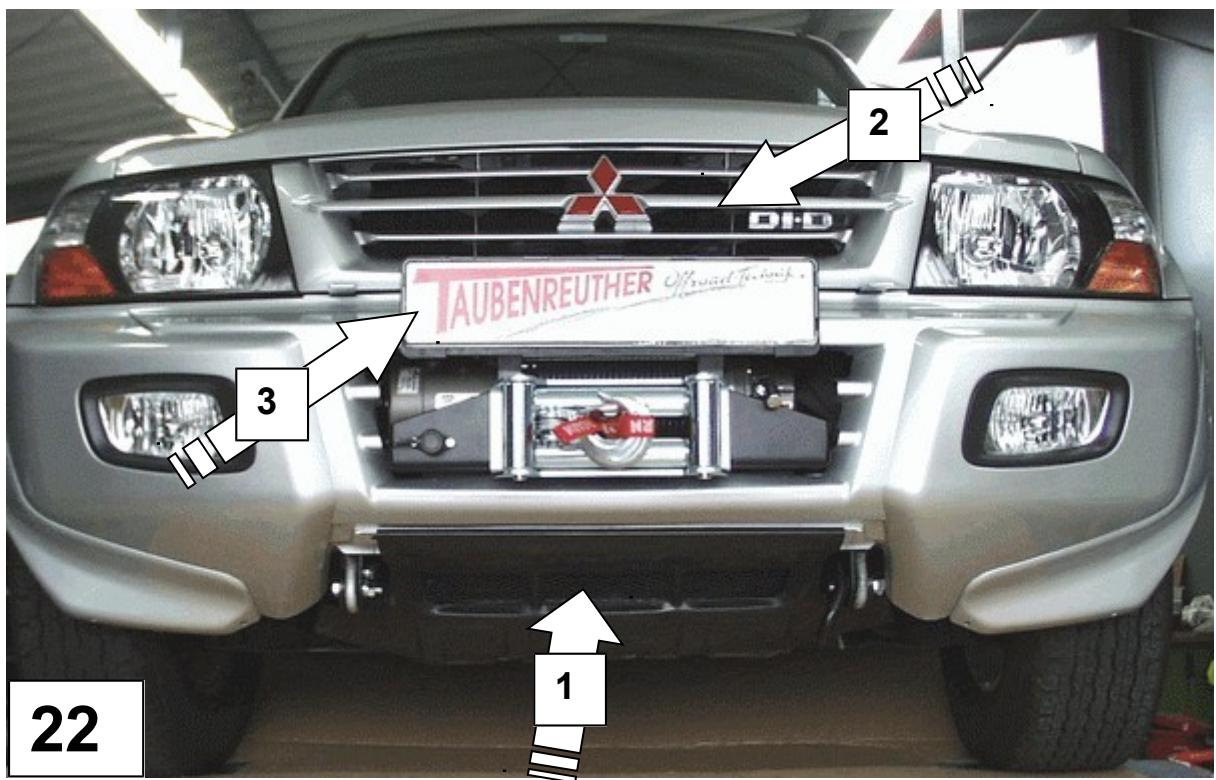

**Die Punkte 23 bis 39 sind für V 80 Modelle**  
*Points 23 to 39 are for V 80 models only*

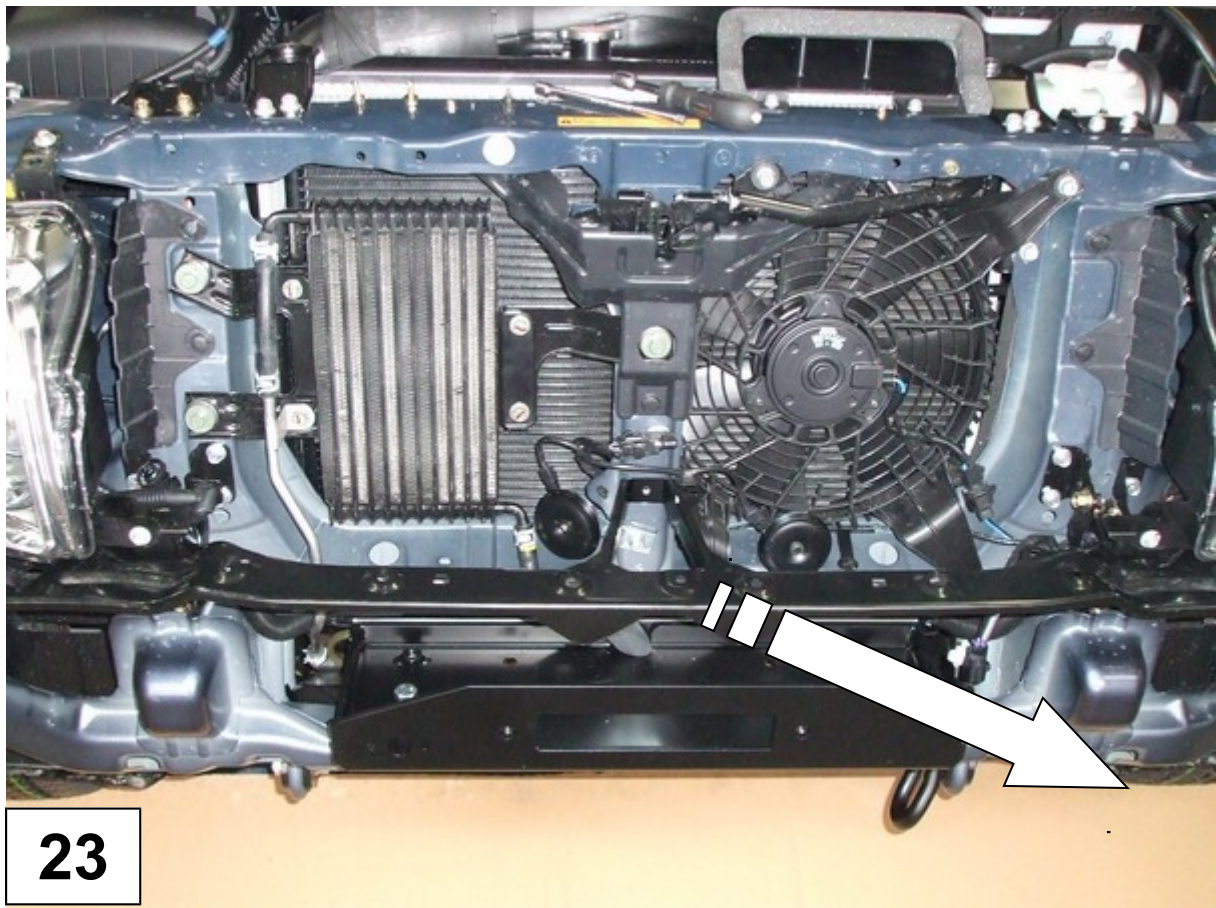





26

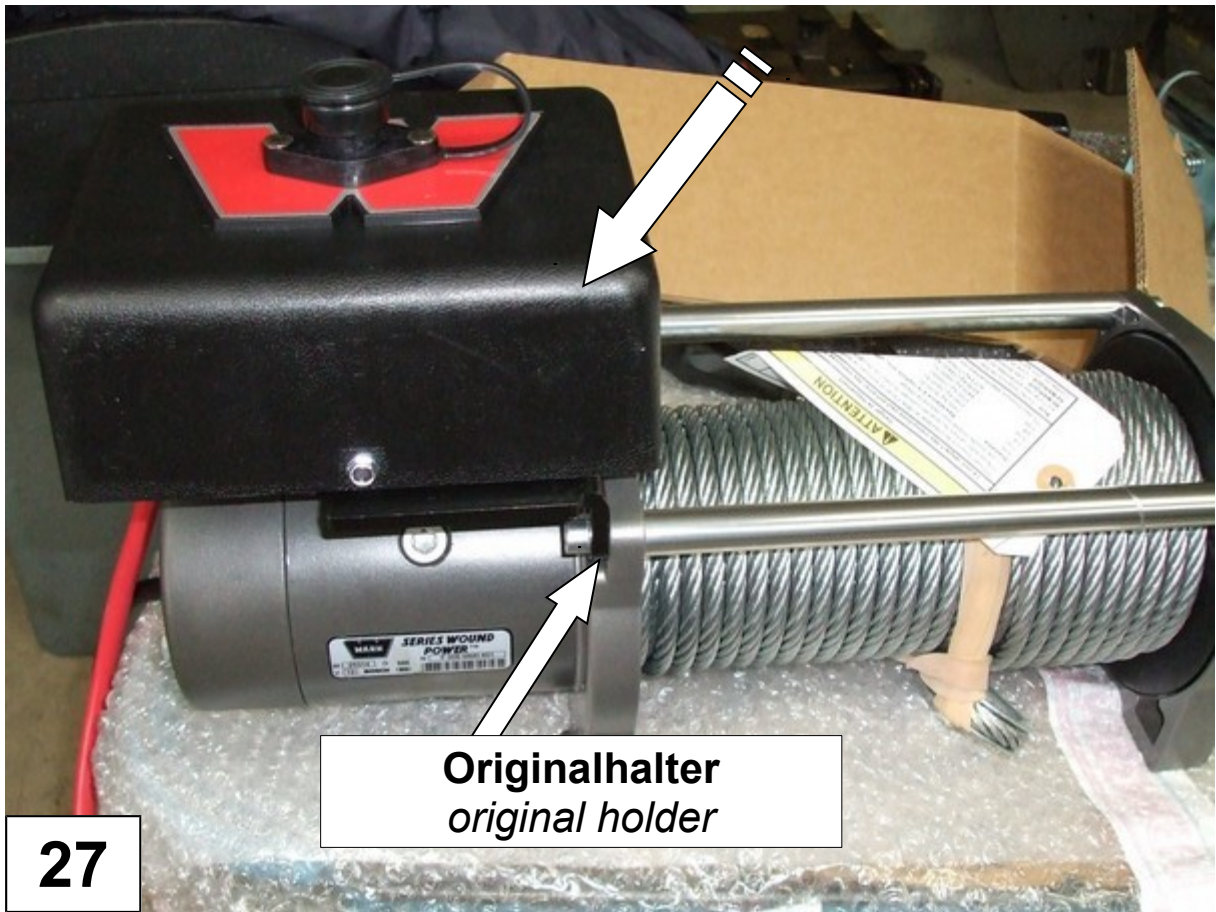

Originalhalter  
original holder

27

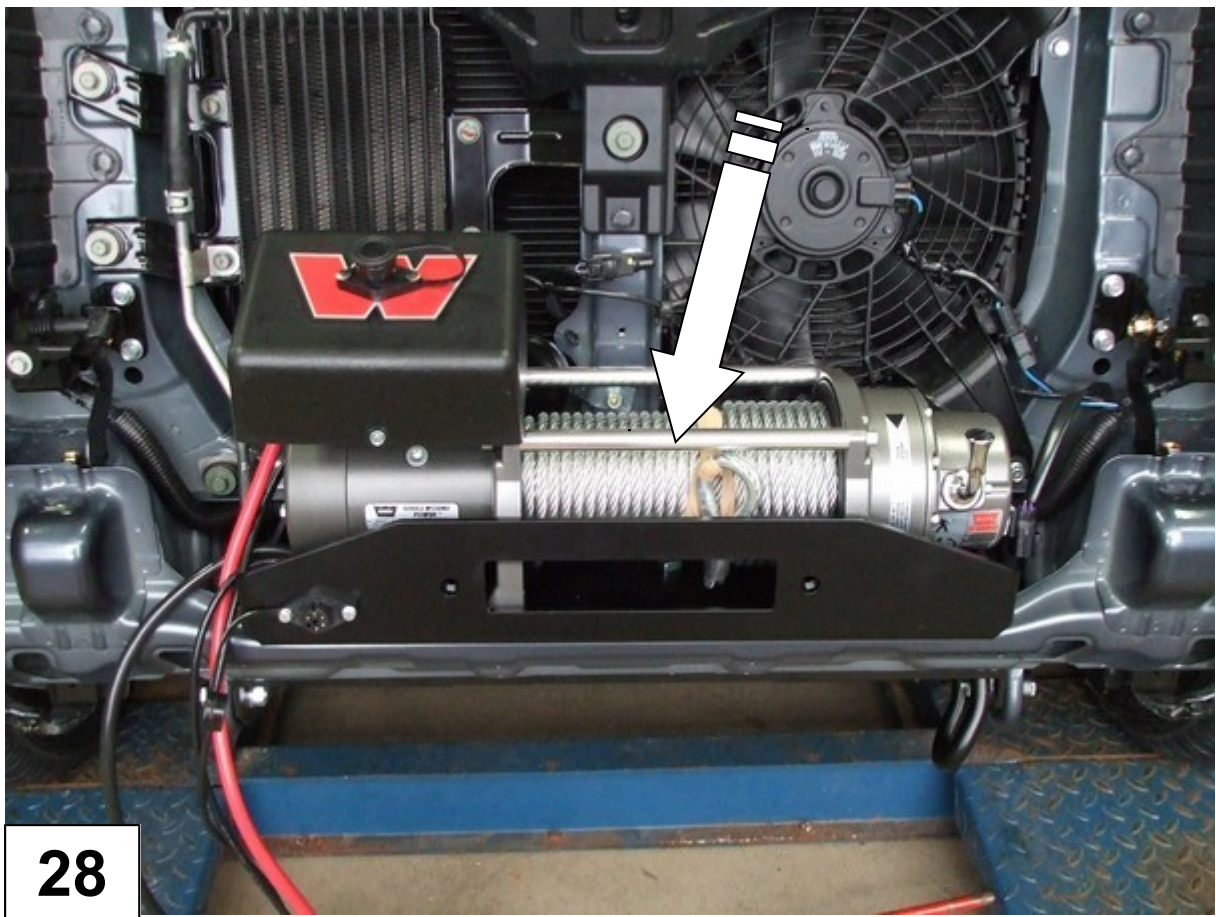

28

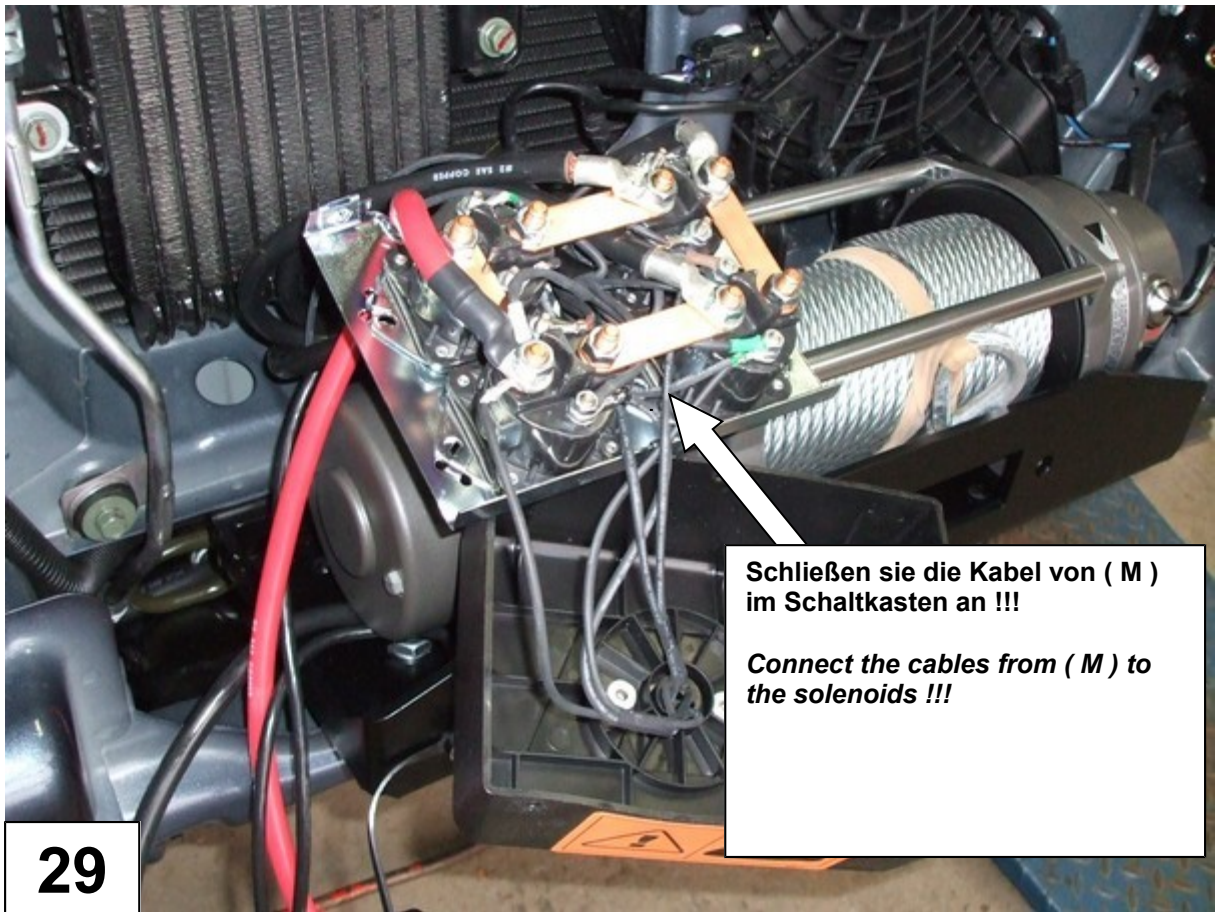

**Schließen sie die Kabel von ( M )  
im Schaltkasten an !!!**

**Connect the cables from ( M ) to  
the solenoids !!!**

29



