

Anbauanleitung: Seilwindenanbausatz Jeep Wrangler JL

AL: 2193-03

Best.Nr.: 16-6620

Montagezeit: ca. 600 min.

***Hier sehen sie den fertig montierten Seilwindenanbausatz optimiert für Warn Zeon
Winden mit Kunststoffseil.***

***Bevor sie mit der Montage beginnen, lesen sie bitte diese Anleitung und das
Benutzerhandbuch der Seilwinde gut durch.***

*Here you see the finish mounted winch mounting kit optimized for Warn Zeon winches with
syntetic rope.*

*Before you start fitting, please read and understand this instruction manual and the owners
manual of the winch.*



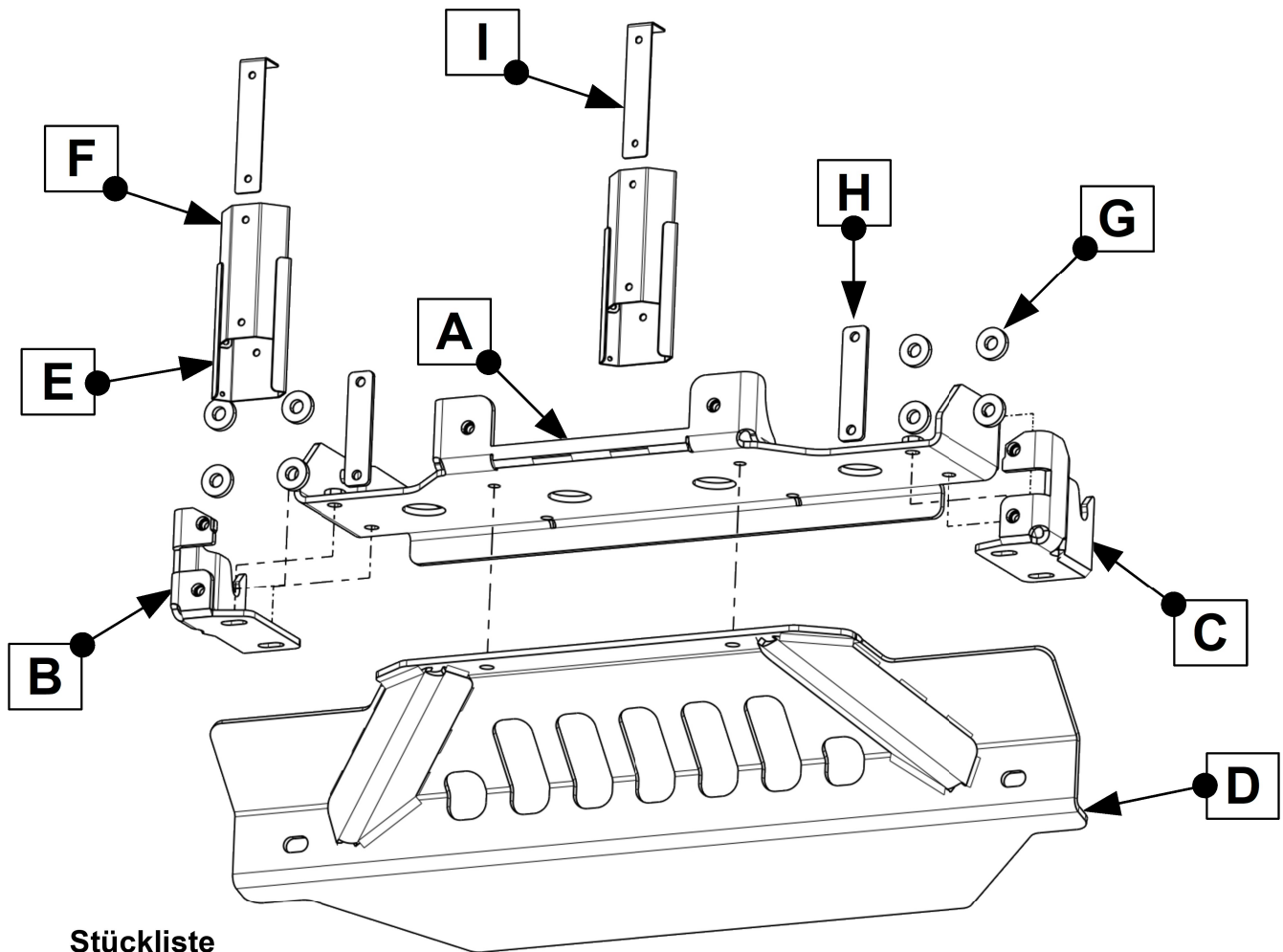

Stückliste

16-662

- 1x Grundplatte (A)
- 1x Seitenteil rechts (B)
- 1x Seitenteil links (C)
- 1x Stützblech (D)
- 2x Unterteil Nummernschildhalter (E)
- 2x Oberteil Nummernschildhalter (F)
- 8x Distanzscheibe (G)
- 2x Gegenblech (H)
- 2x Anschlagwinkel (I)

8x 16-0519, Druckstück D6 x L7

Nur bei Kunststoffseil notwendig!

- 1x 10-76101, Adapter 50mm für Seilfenster
- 2x 10-76100, Distanz 6mm

- 1x Anbauanleitung AL2193
- 1x Gutachten+Aufkleber

Schraubensatz

- 4x Schraube M10 x 40
- 6x Schraube M10 x 30
- 2x Senkschraube M10 x 60
- 2x Senkschraube M10 x 90
- 10x Scheibe M10 x 30 x 3
- 10x Federring M10

- 9x Flanschkopfschraube M6 x 16
- 13x Scheibe M6 x 20 x 1,25
- 9x Federring M6
- 9x Mutter M6

Schrauben Anzugsmomente	
Schraubengröße	Güteklasse - 8.8
M6	10 Nm
M8	25 Nm
M10	50 Nm
M12	87 Nm
M14	138 Nm
M16	210 Nm







5

Inneren Winkel entfernen! Wird an der linken Außenseite wieder verbaut.
Remove the bracket inside! Will mount on the left outside again!



6



7 Nur fixieren! / *Fix in place!*

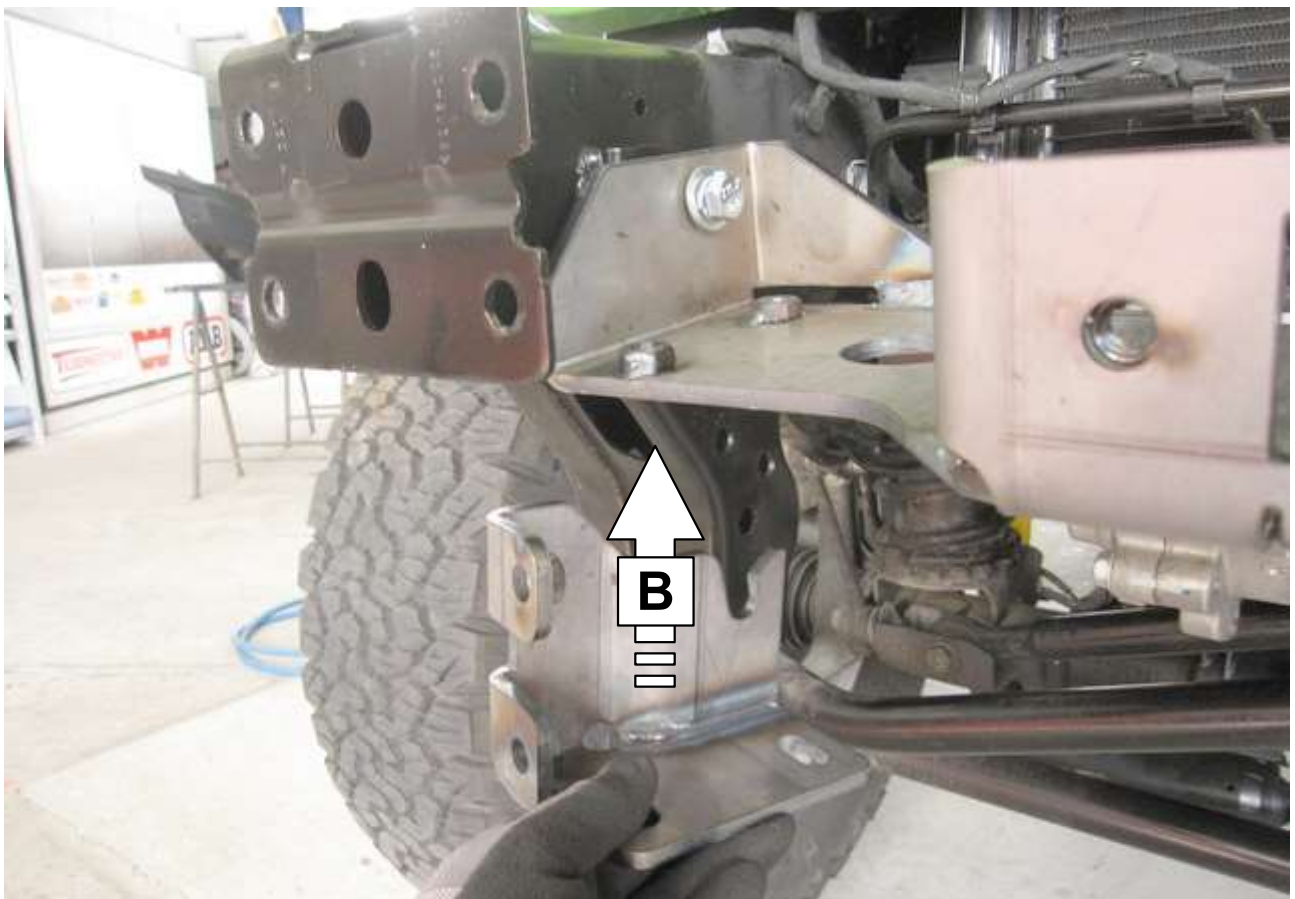

8 Zwischen Rahmen und Windenplatte! Das Gleiche an der linken Seite
Between frame and winch plate! The same at the left side!



M10 x 30

9 Das Gleiche an der linken Seite! / *The same at the left side!*

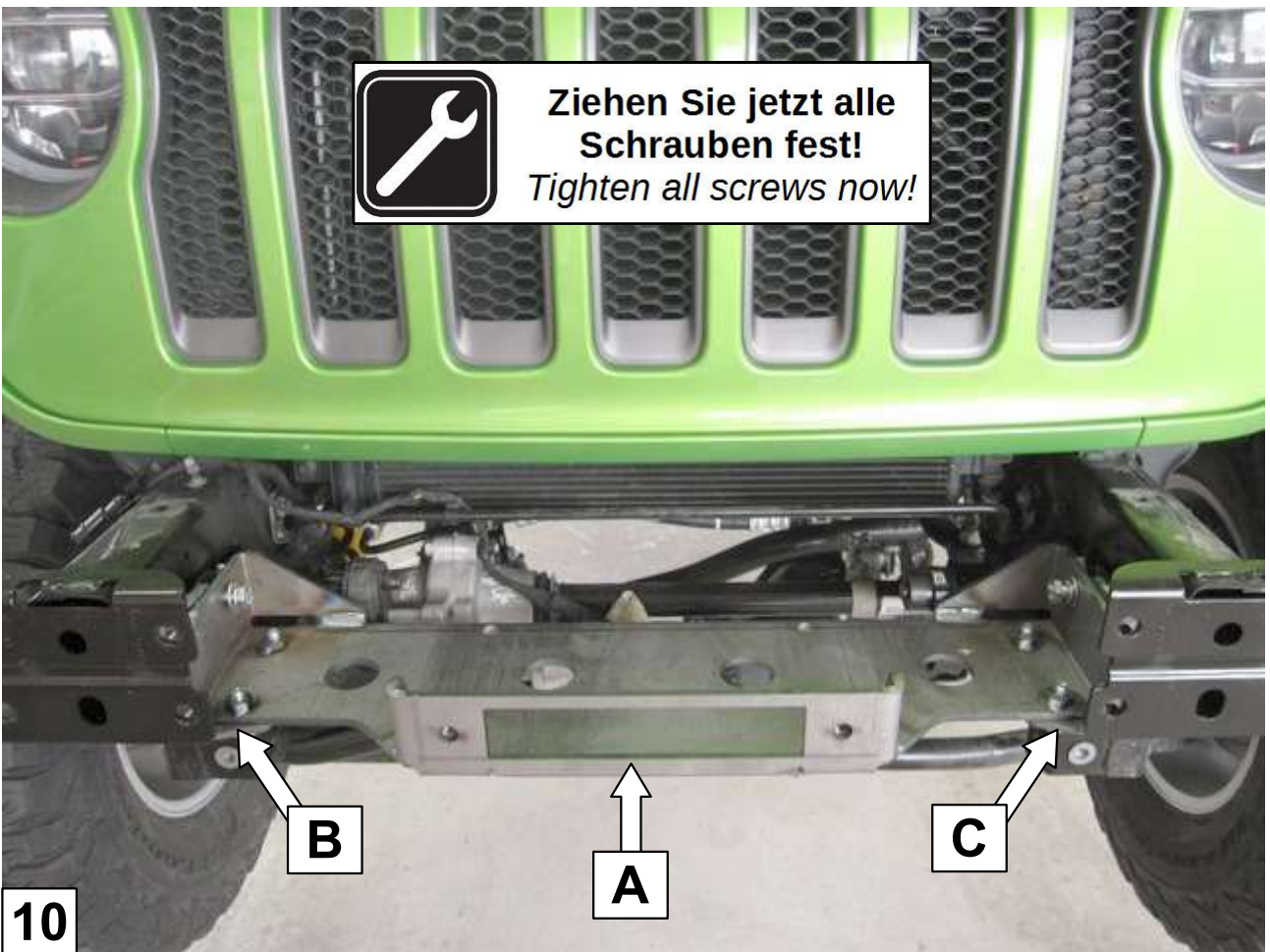

Ziehen Sie jetzt alle
Schrauben fest!
Tighten all screws now!

B

A

C

10

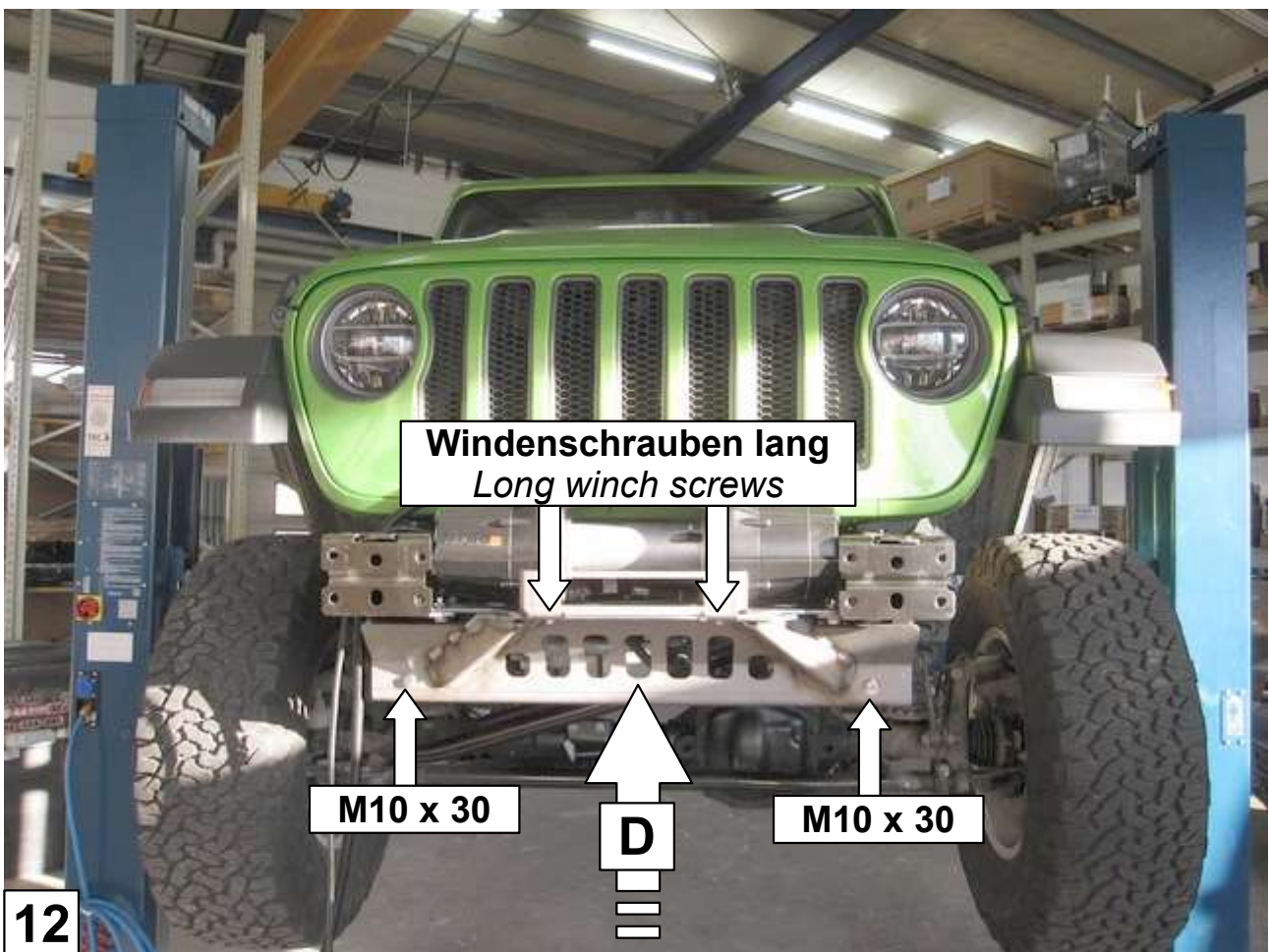

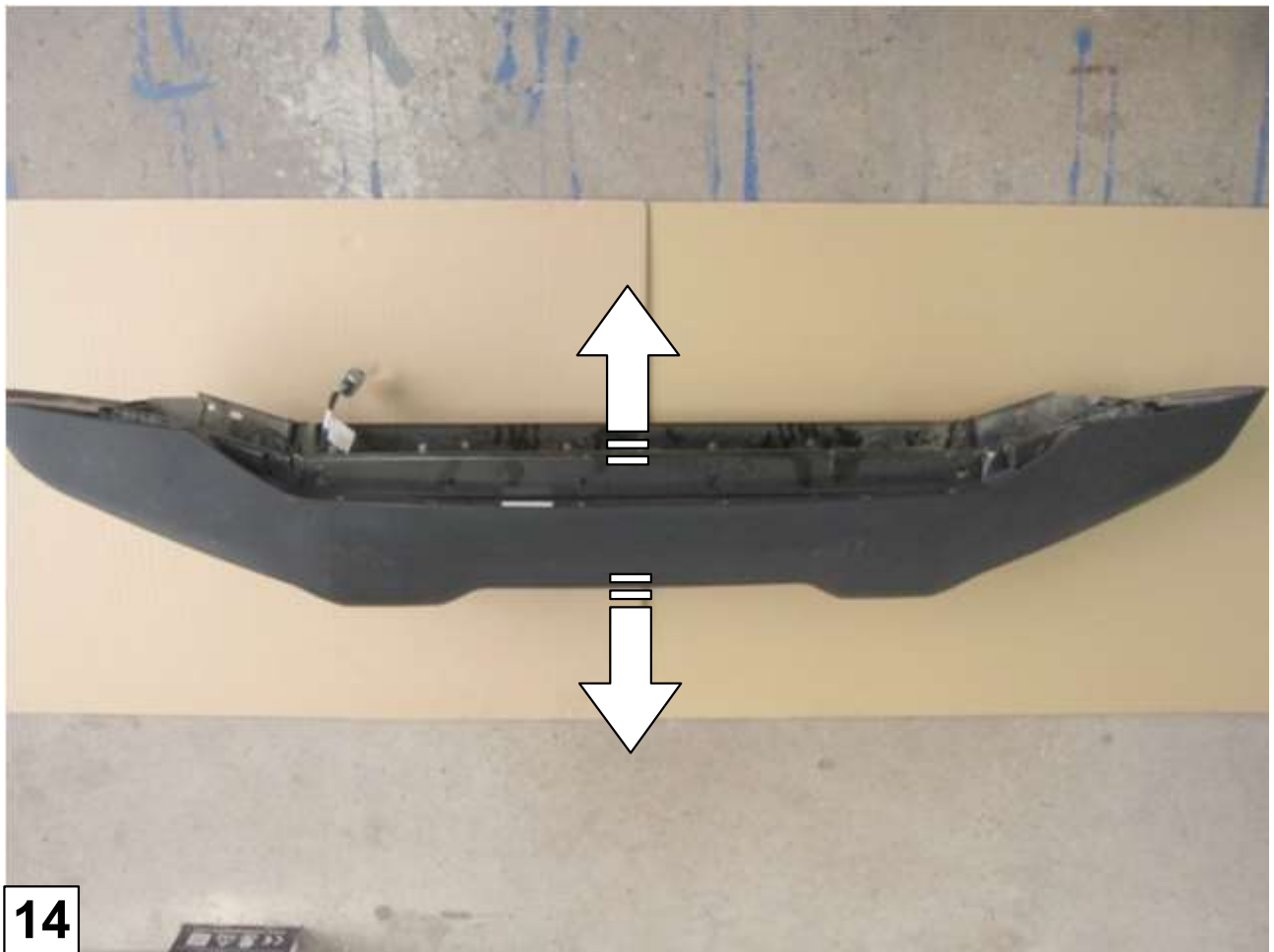

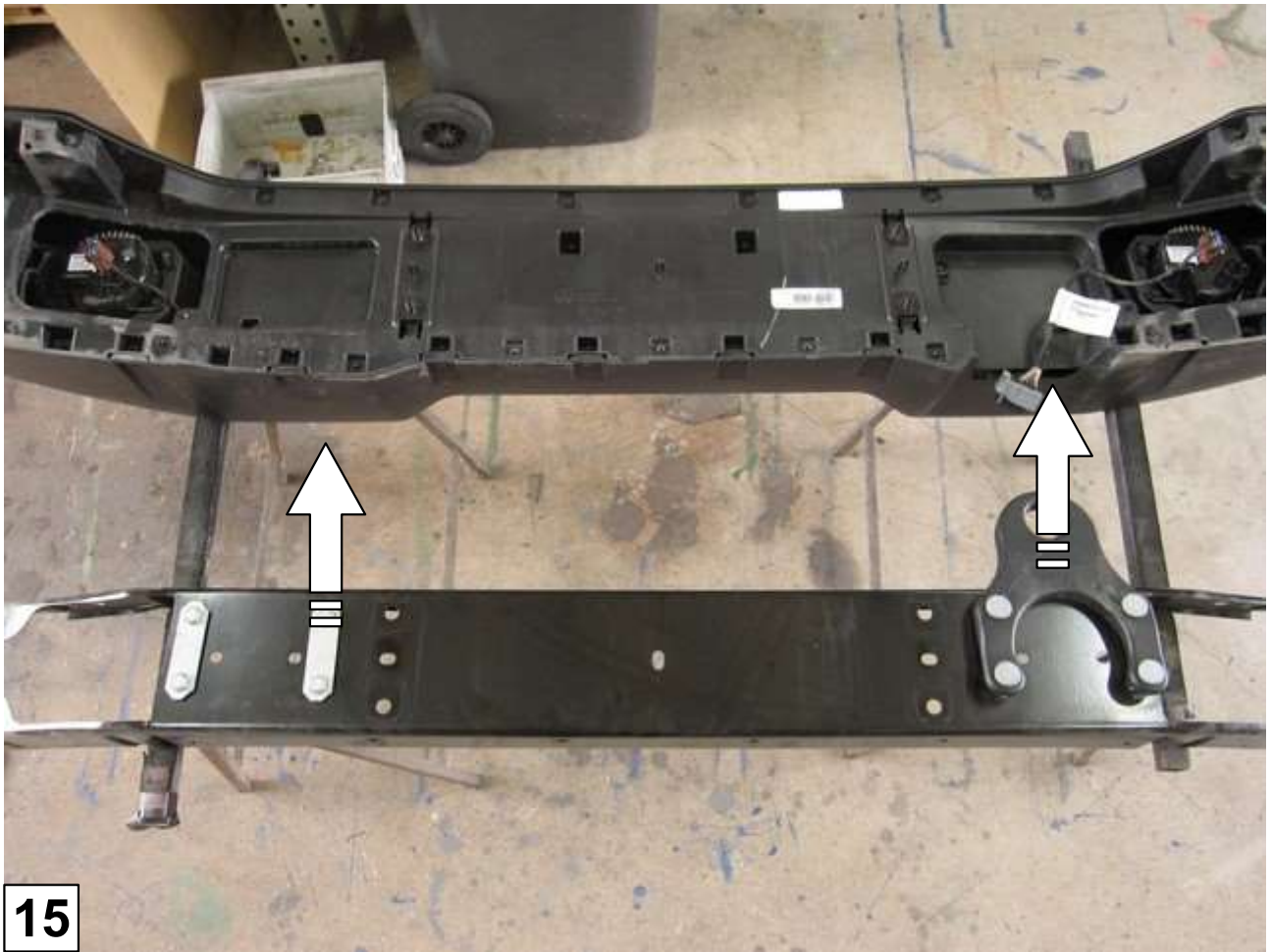

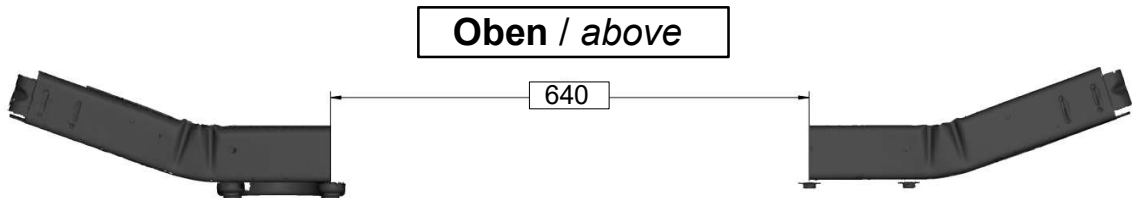
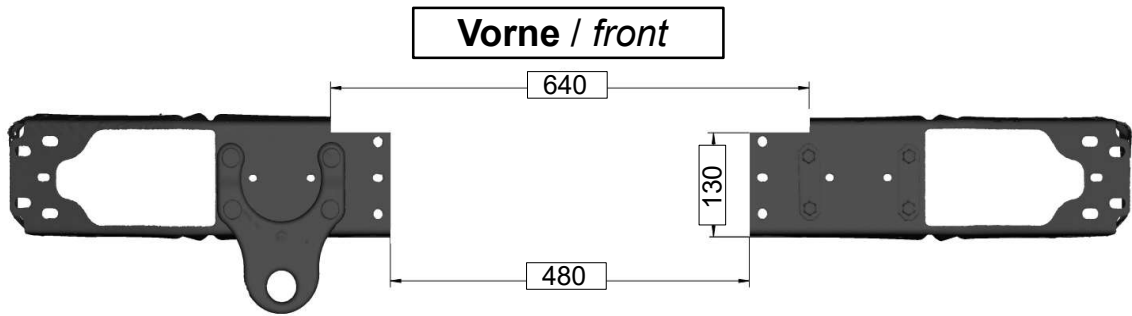
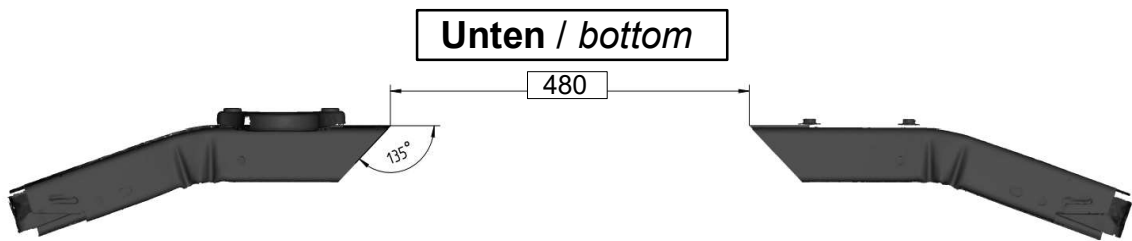

17

Traverse ausschneiden! / Cut out traverse!



18

**Für ausreichend Rostschutz sorgen!
Ensure adequate rust protection!**

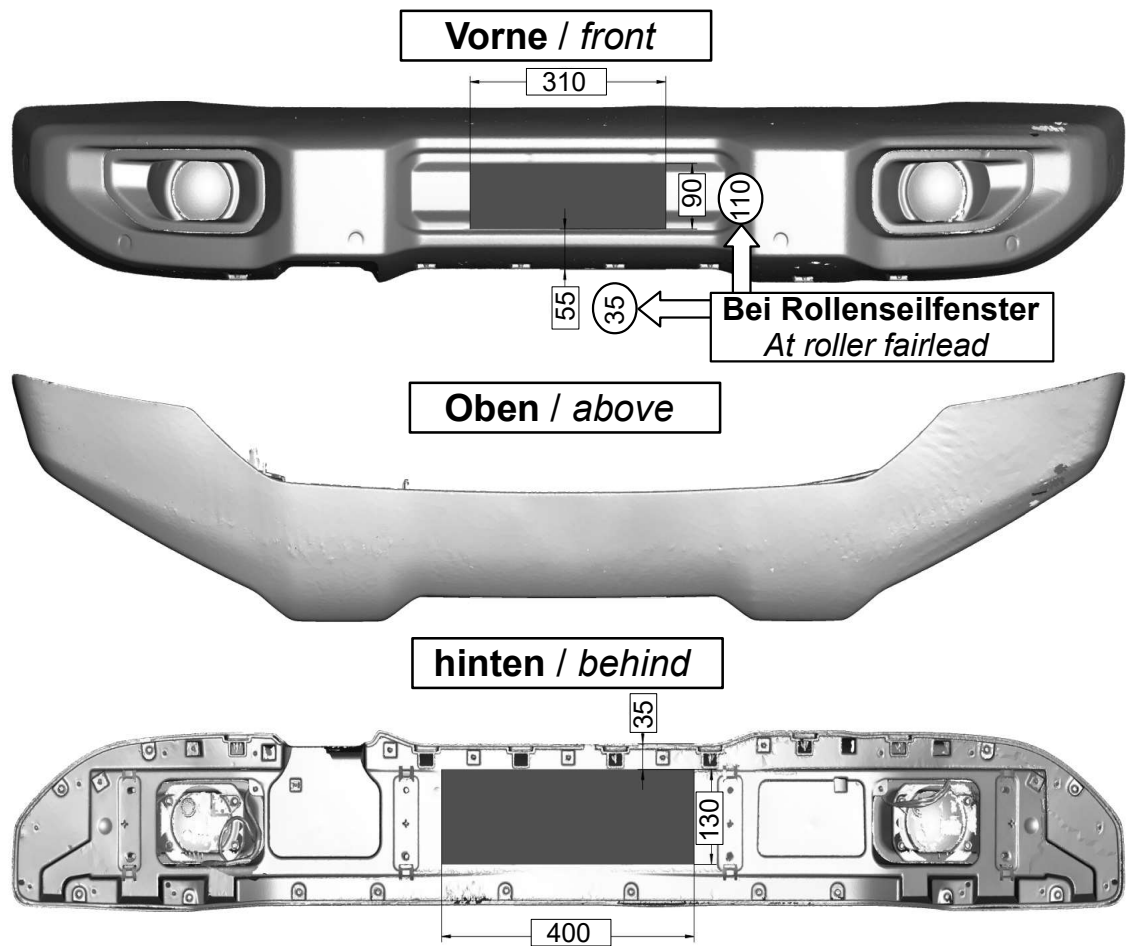

19

Ausschneiden! / Cut out!

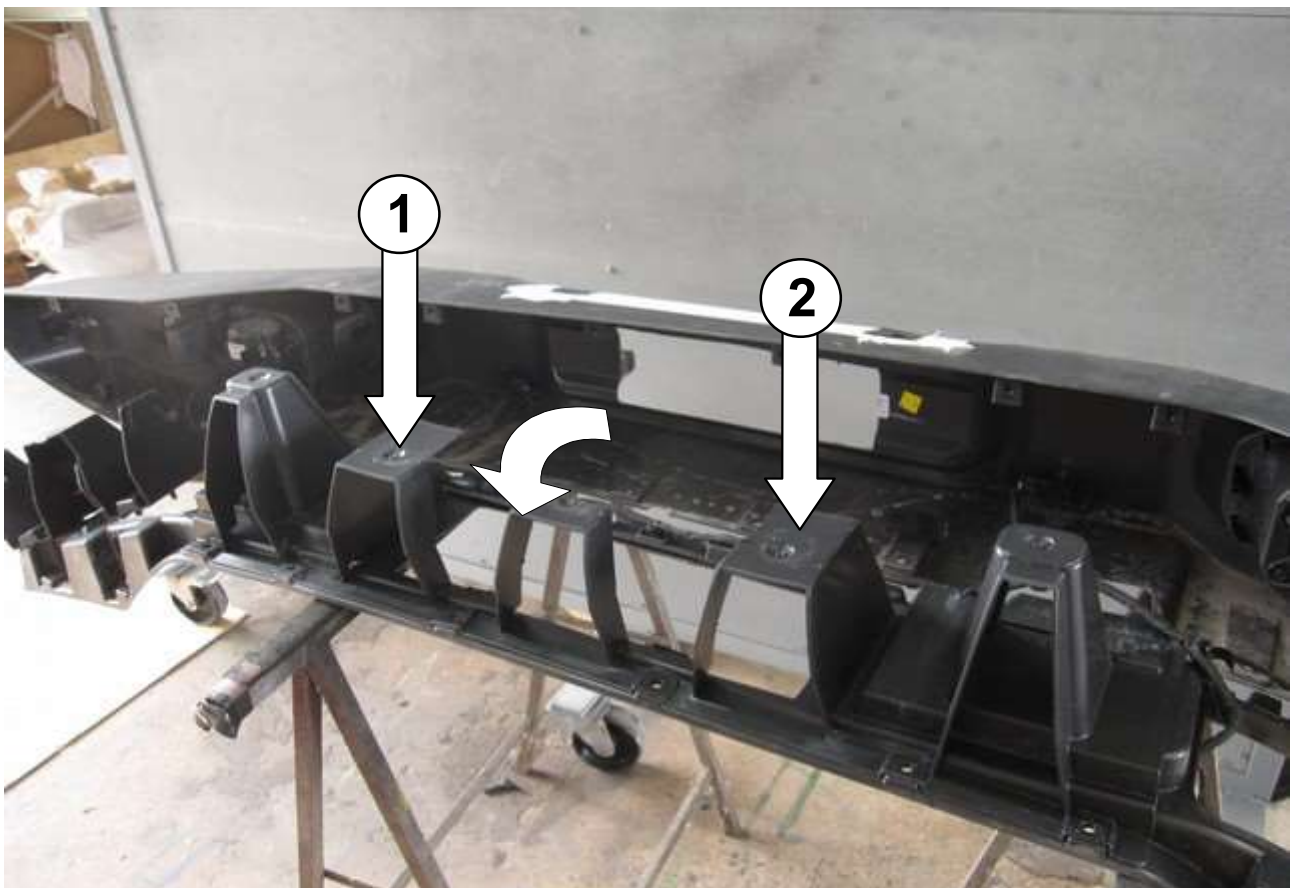

20

Innenteil demontieren, Verstärkungen 1 und 2 abschneiden!
Remove inner part, cut off stiffener 1 and 2!

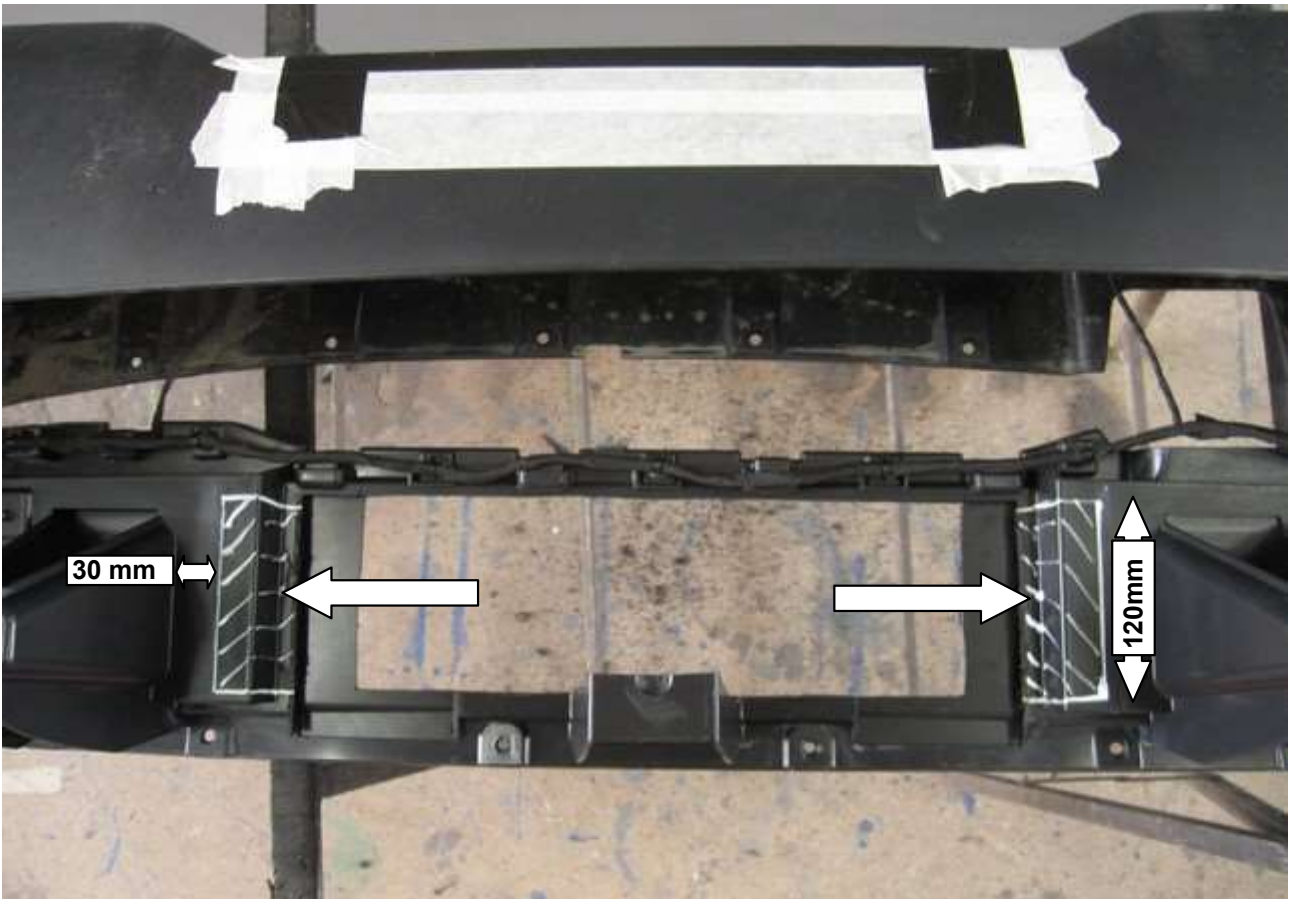

21

Innenteil Ausschneiden! / Cut out inner part!



22

Gewindeleisten entfernen, werden wieder verwendet! (Bild 36)
Remove threaded plates, they will be used again! (Pic.36)

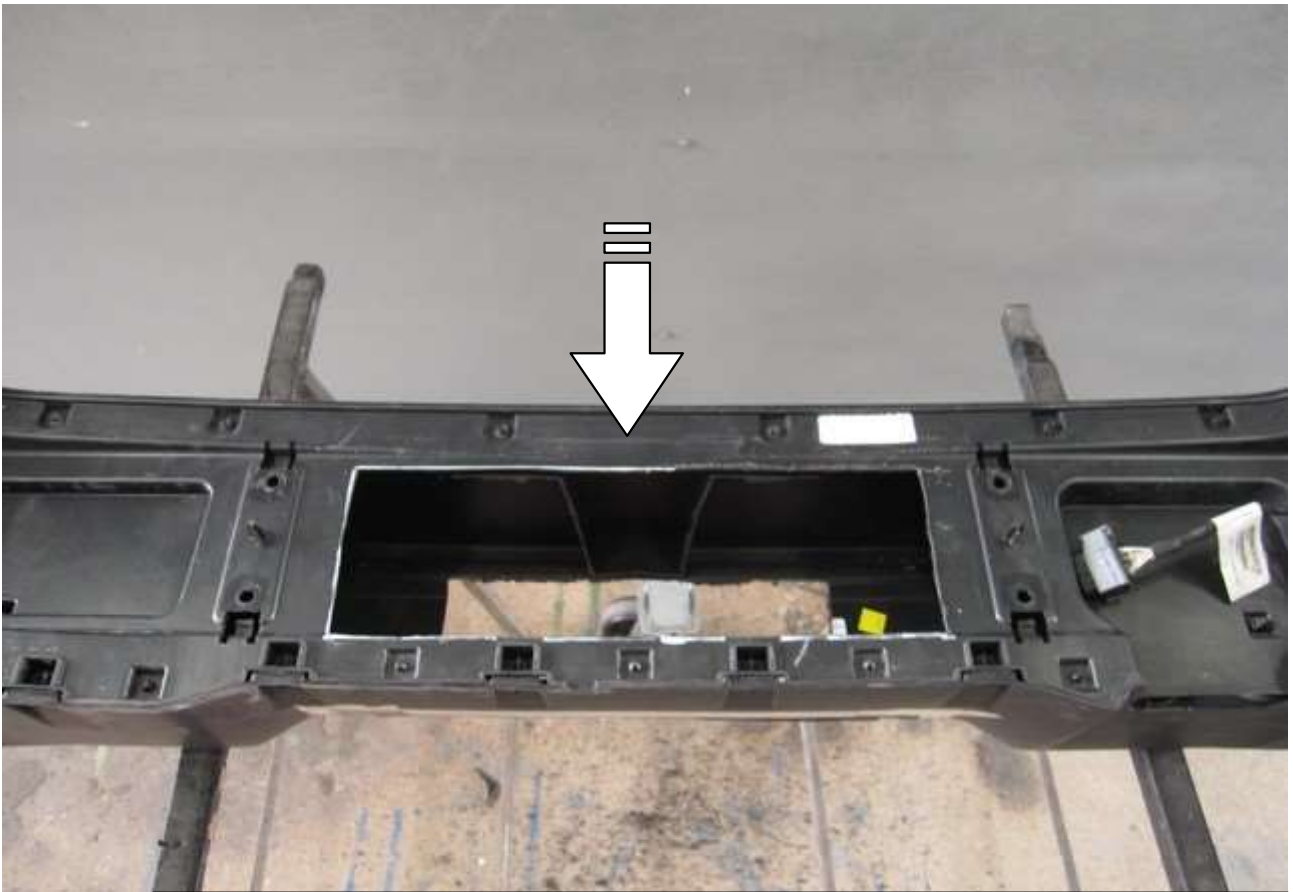

23

Stoßfänger wieder zusammenbauen!
Assamble the bumper again!



24

Zapfen links und rechts entfernen!
Cut off pins left and right!



25

Bohren Ø 6,5mm! / drill Ø 6,5mm!

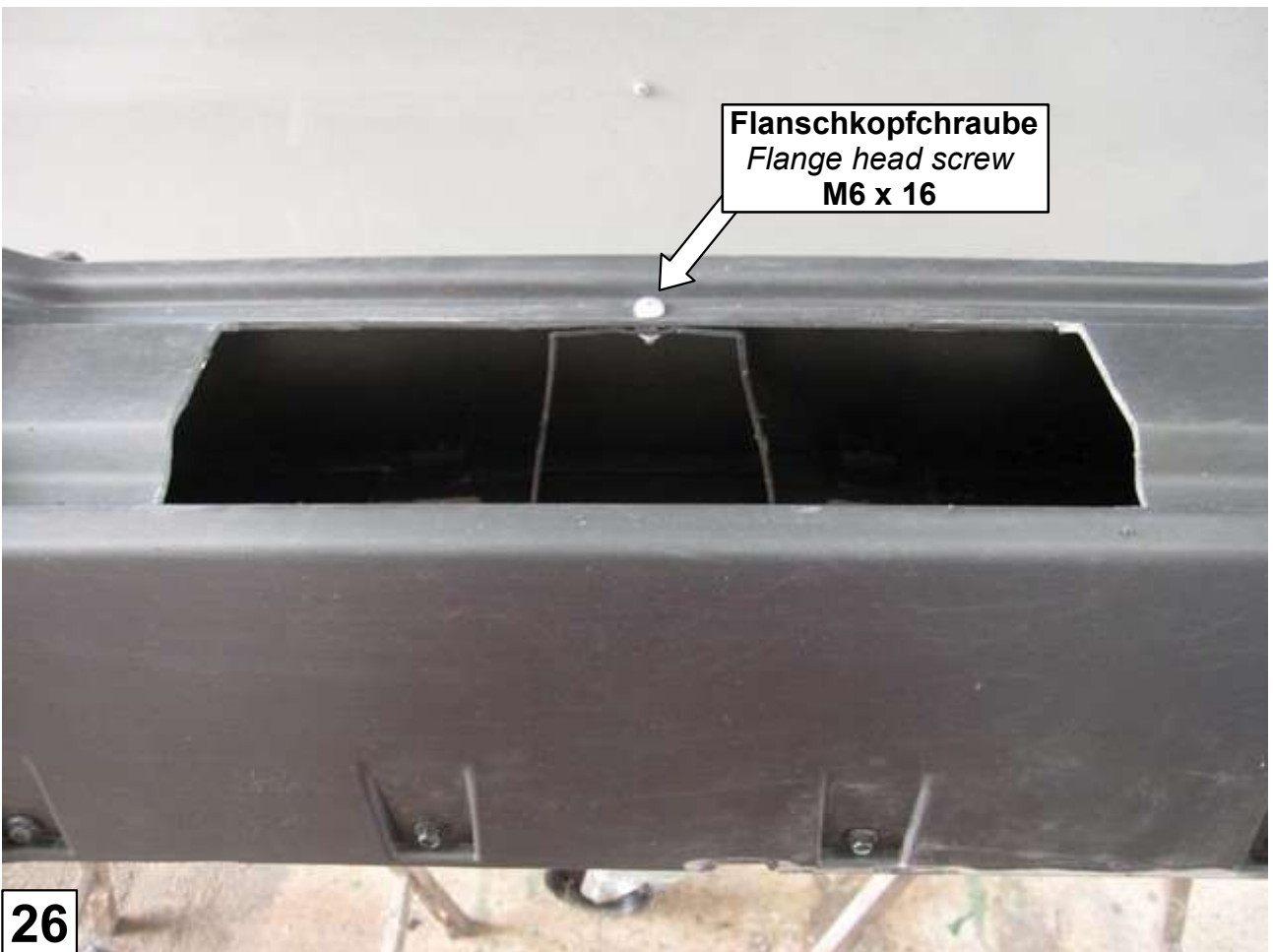

26

Flanschkopfchraube
Flange head screw
M6 x 16



27

Abschneiden! / Cut off!

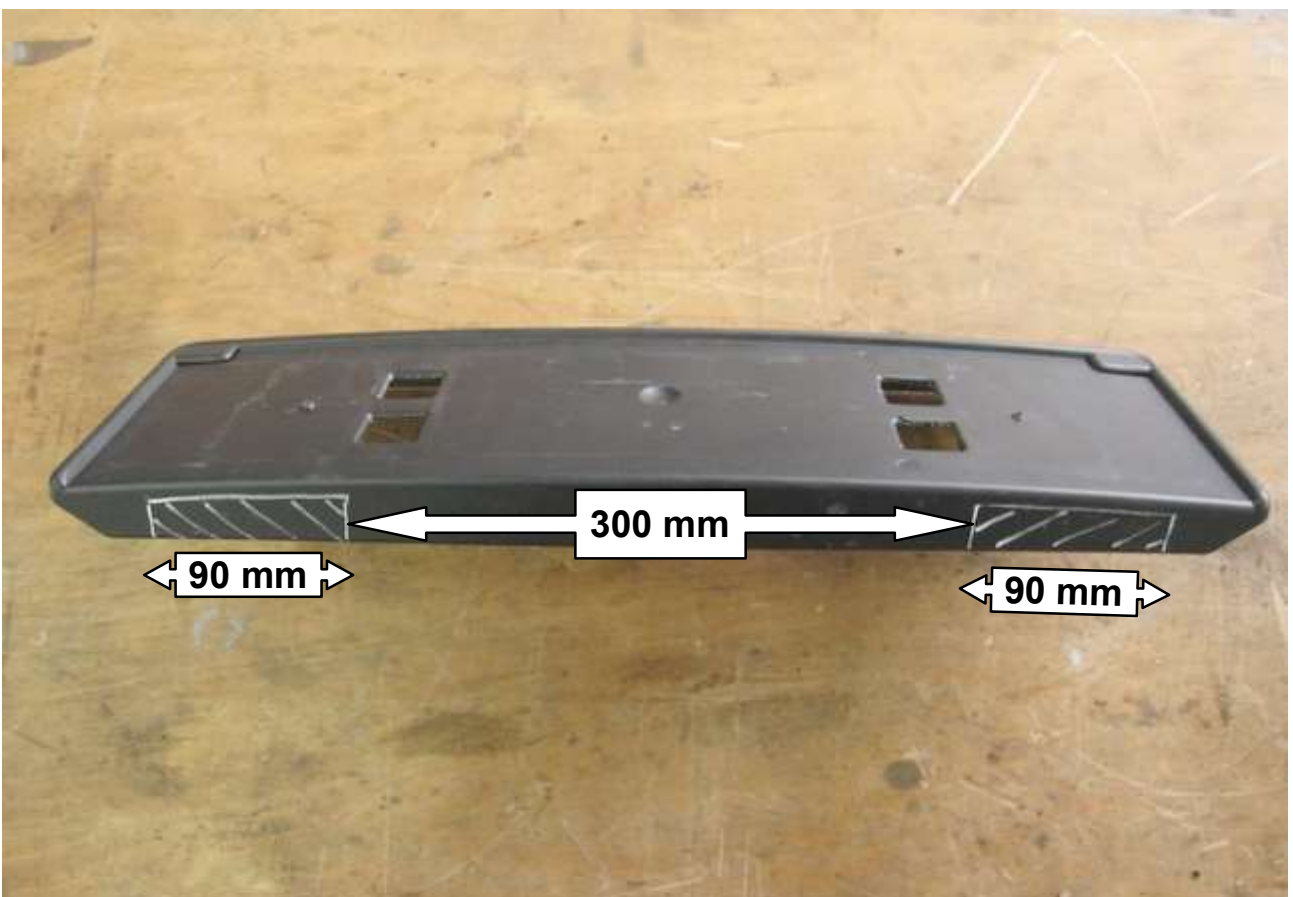

28

Ausschneiden! / Cut out!

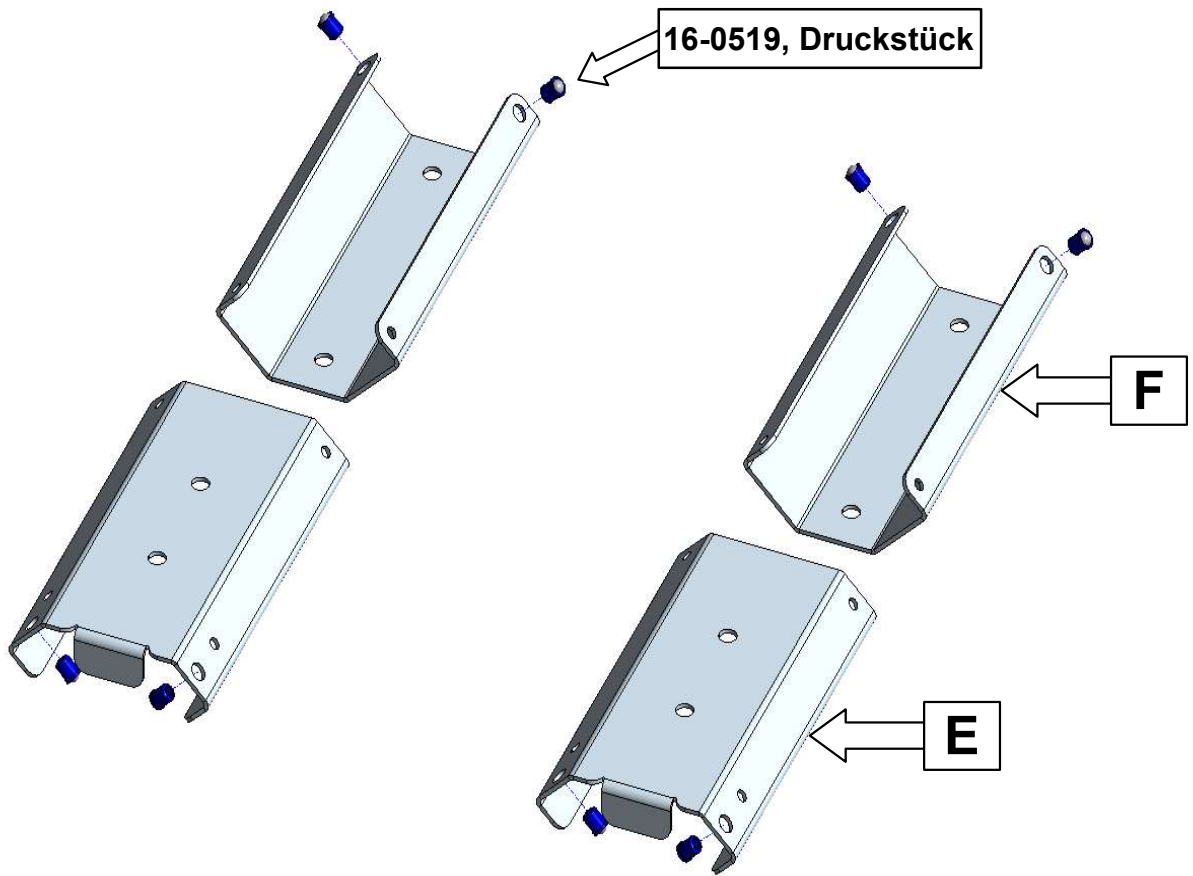

29

Druckstücke montieren! / Mount the pressure pieces!

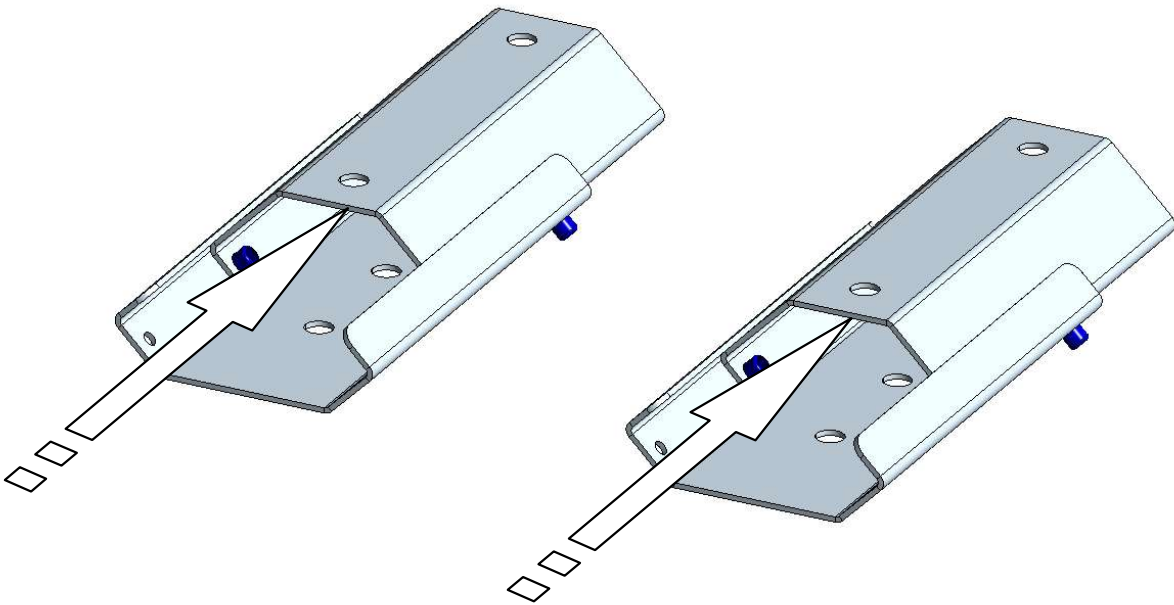

30

Ineinander schieben! / Shove into each other!

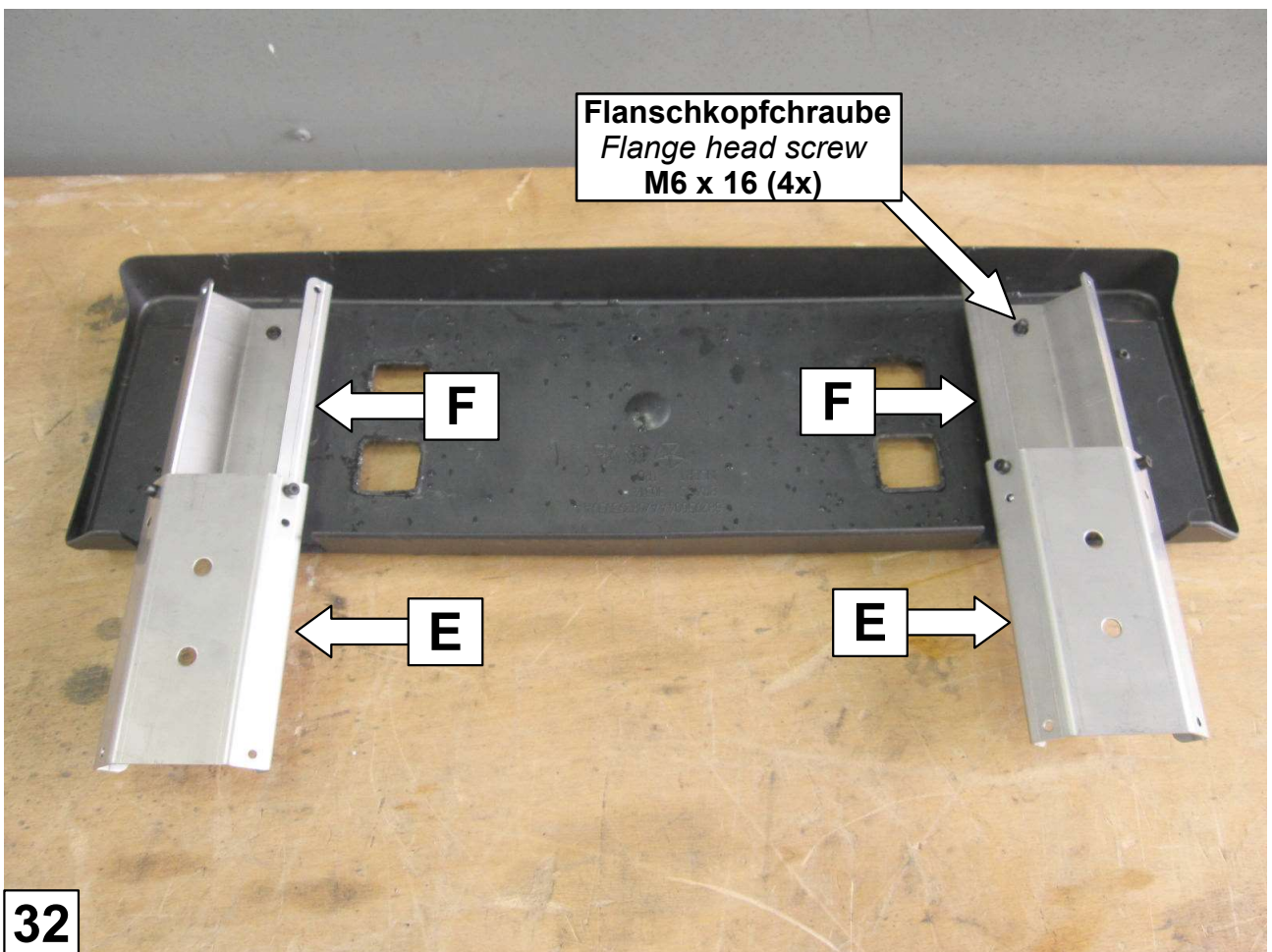
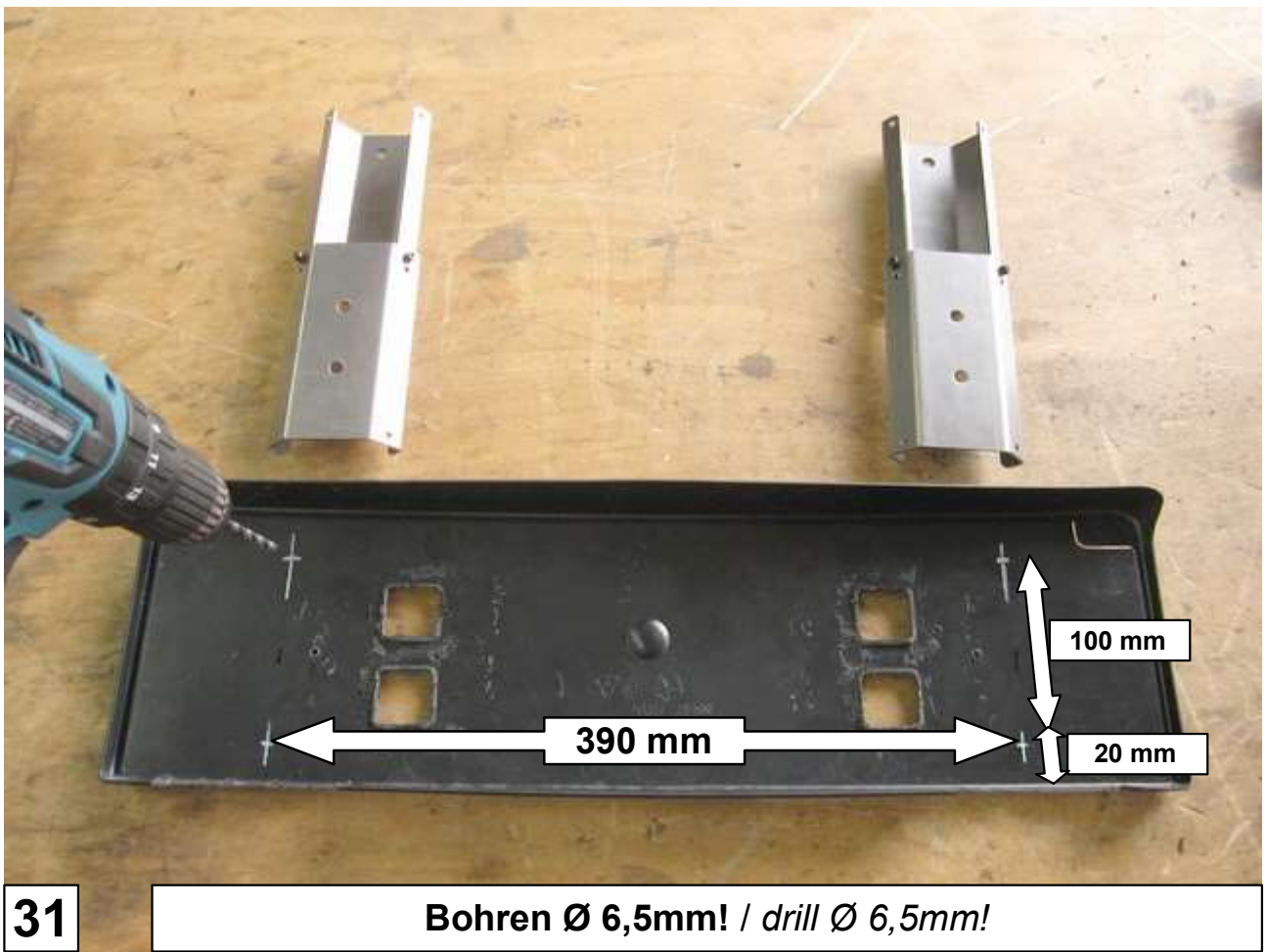

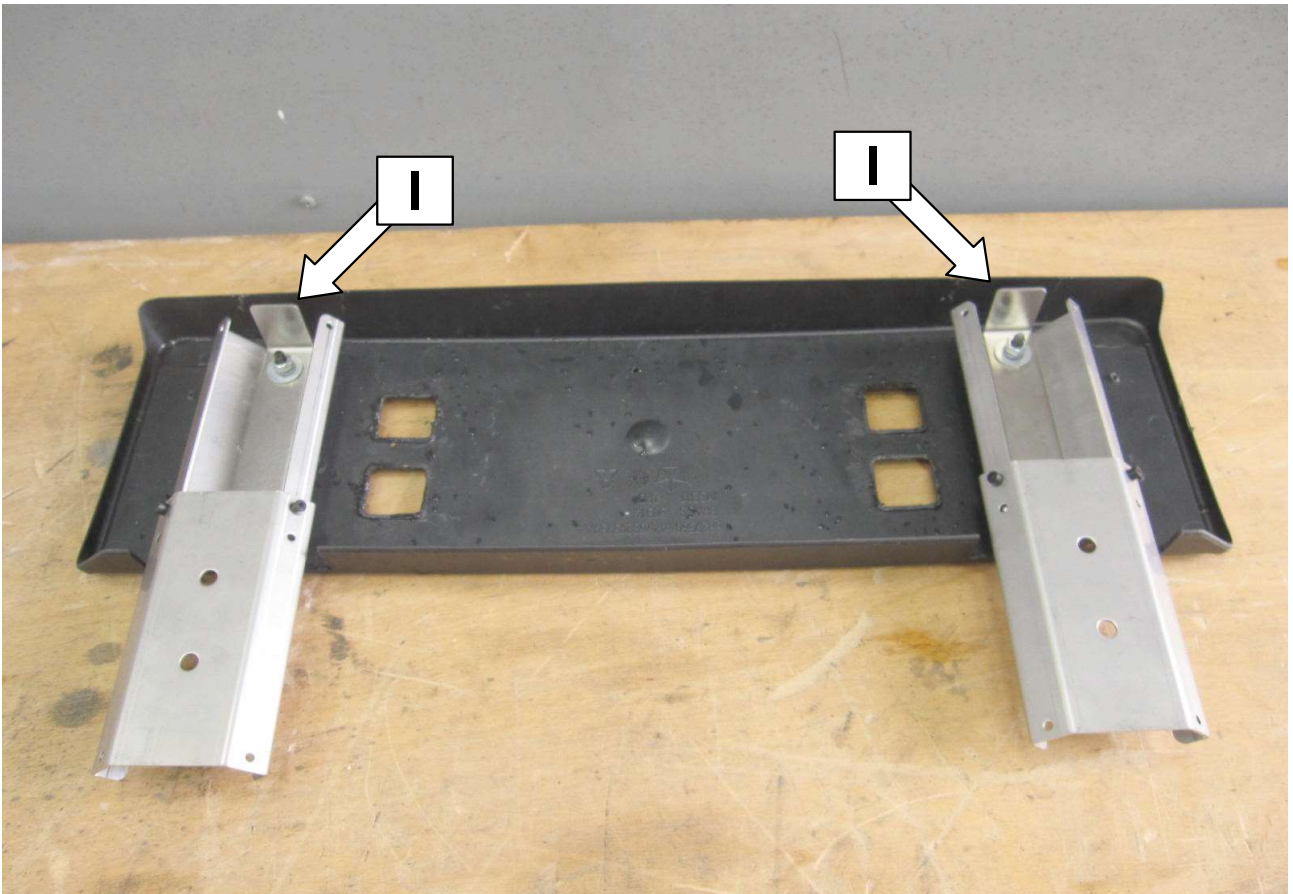

33

Verschrauben! / Screw together!

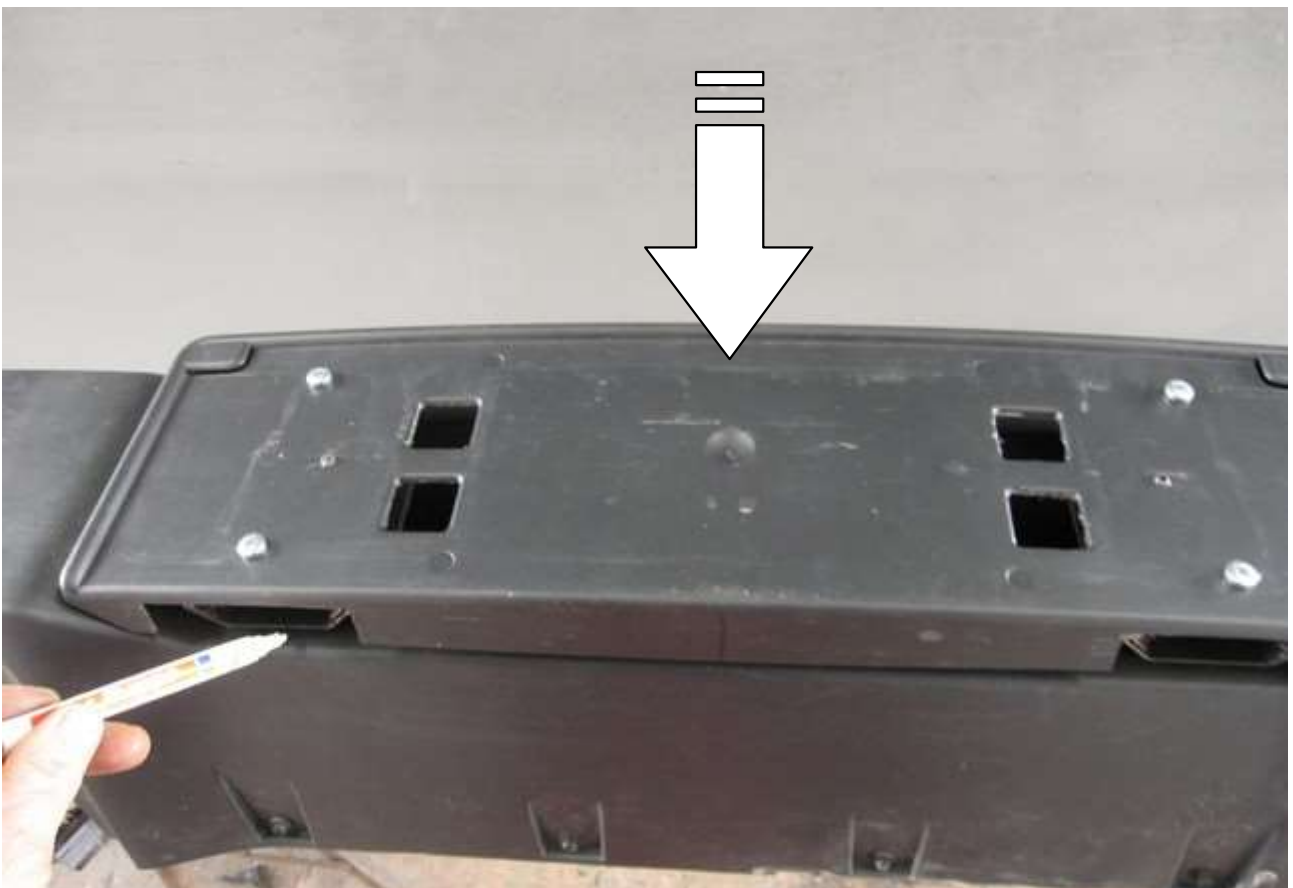

34

Auf den Stoßfänger legen und die Unterkante anzeichnen!
Put it on the bumper and mark the lower edge!

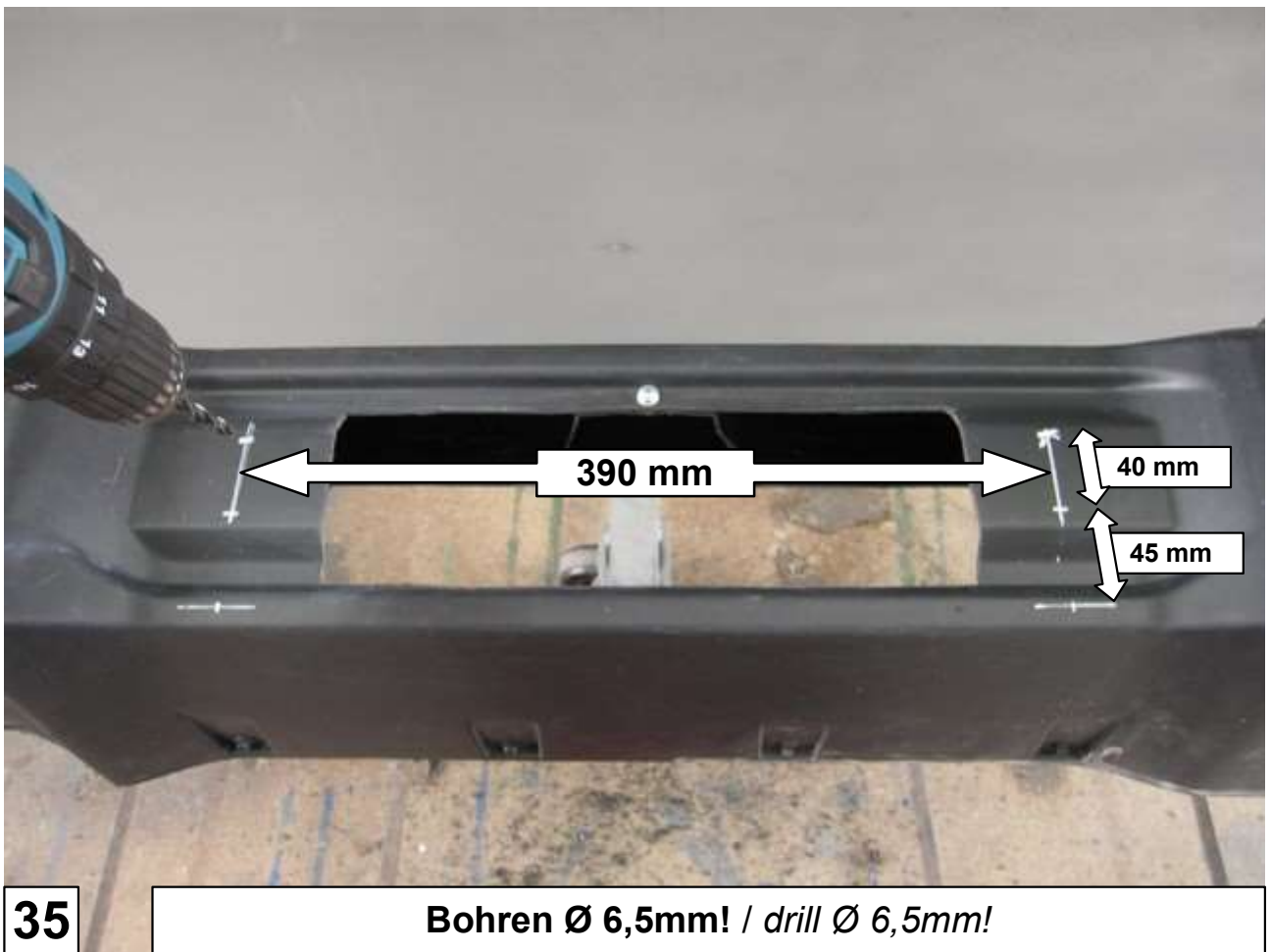

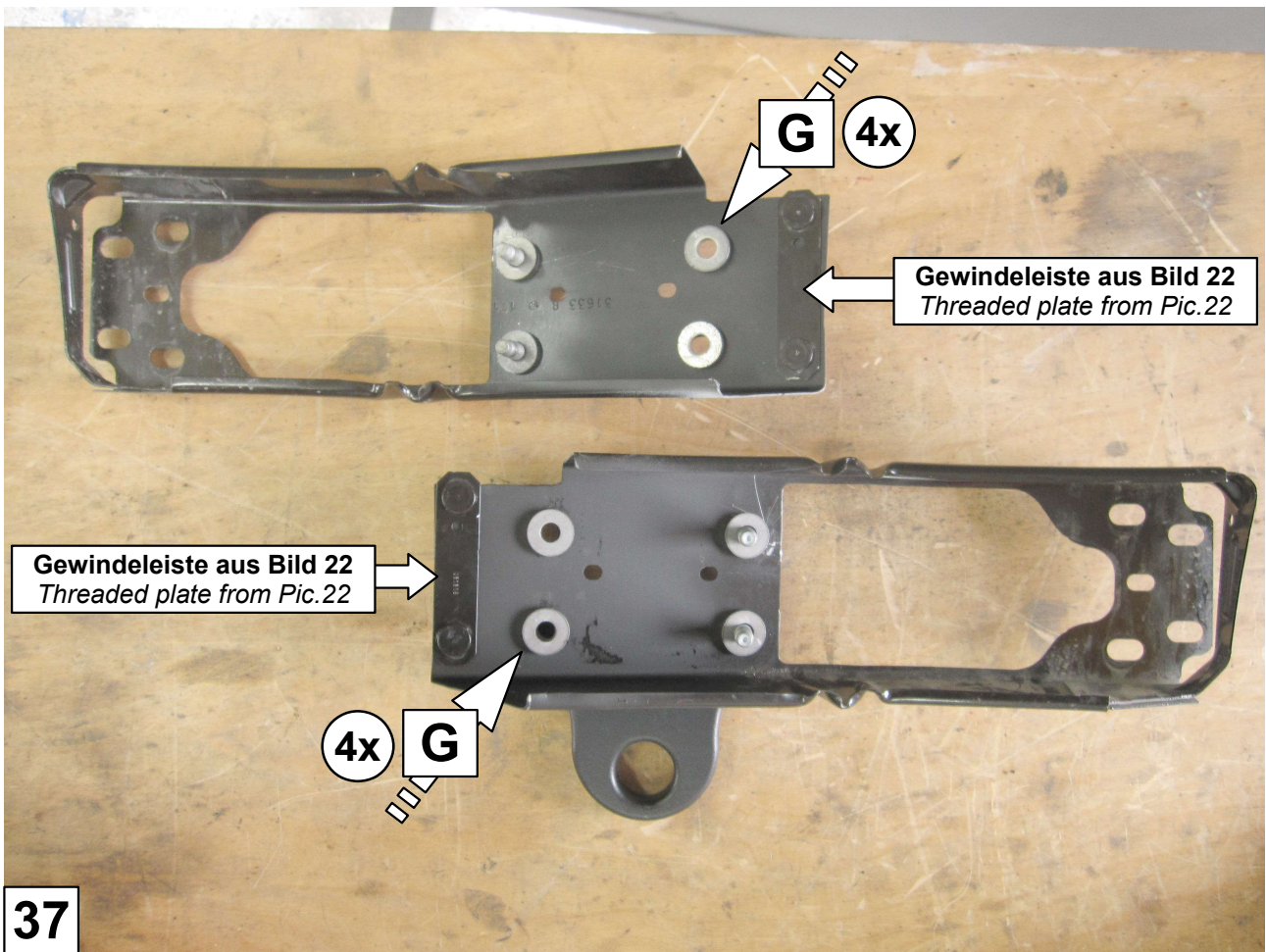

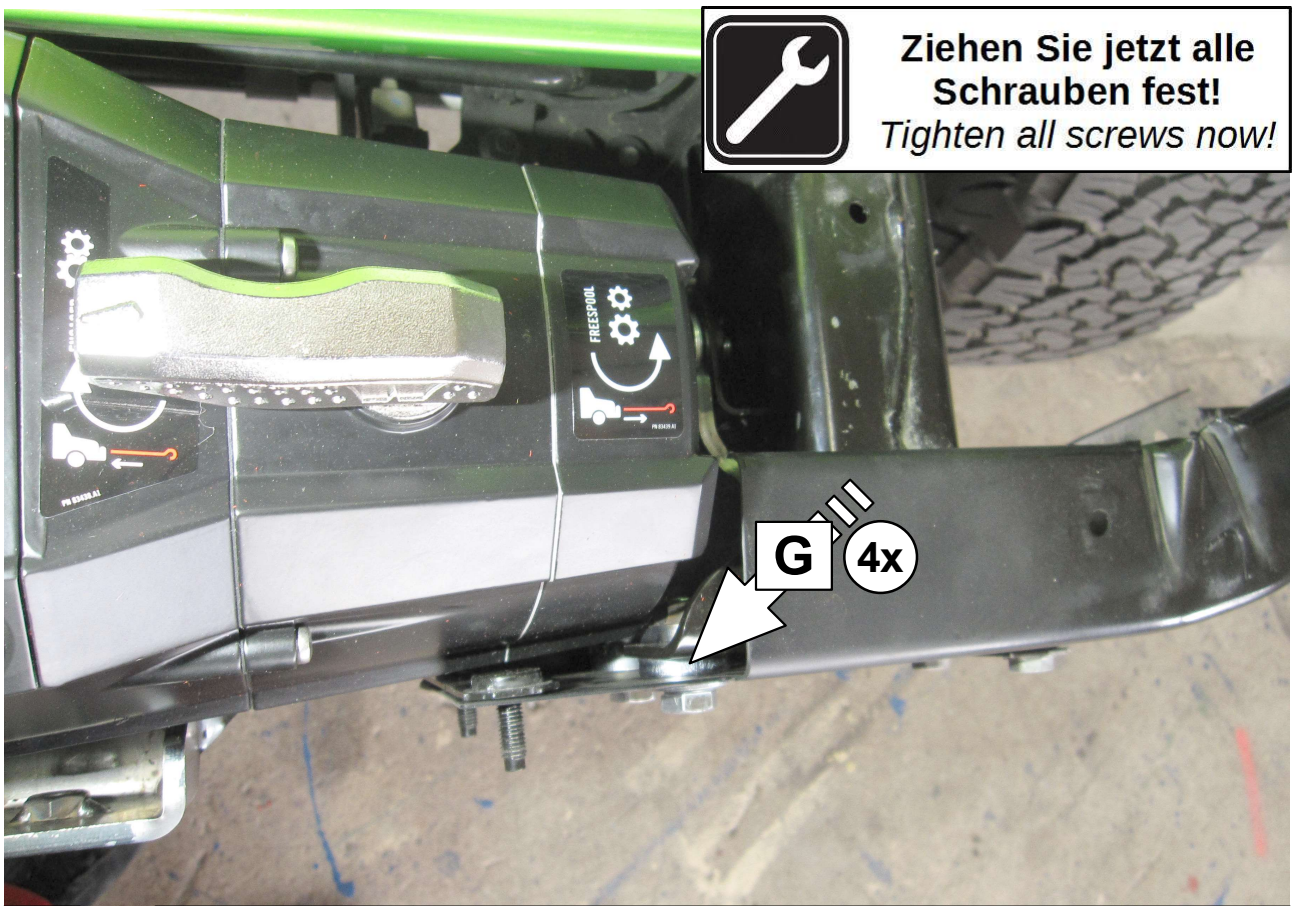

39 **Das Gleiche an der rechten Seite / The same at the right side!**



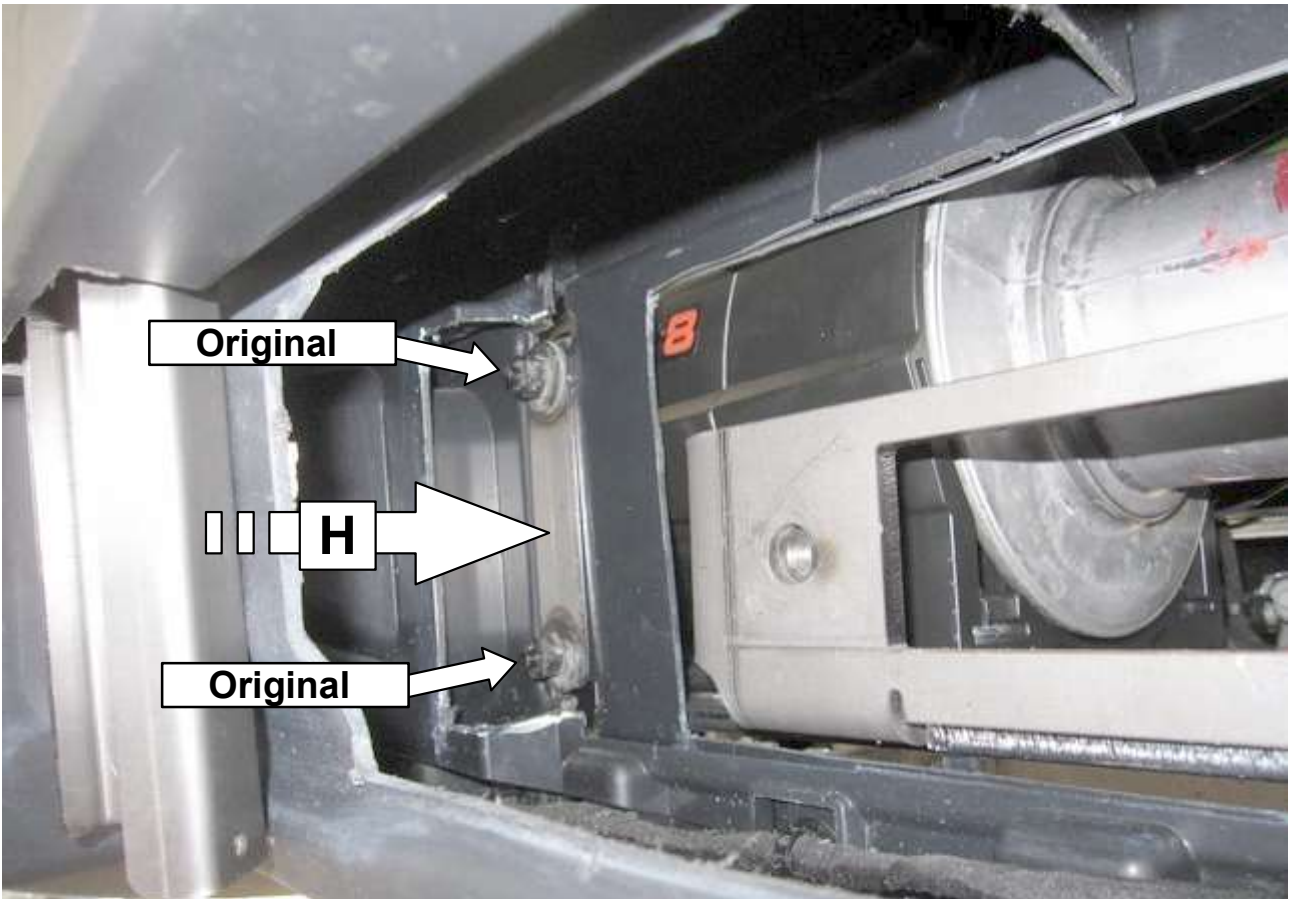

41 Das Gleiche an der linken Seite / *The same at the left side!*

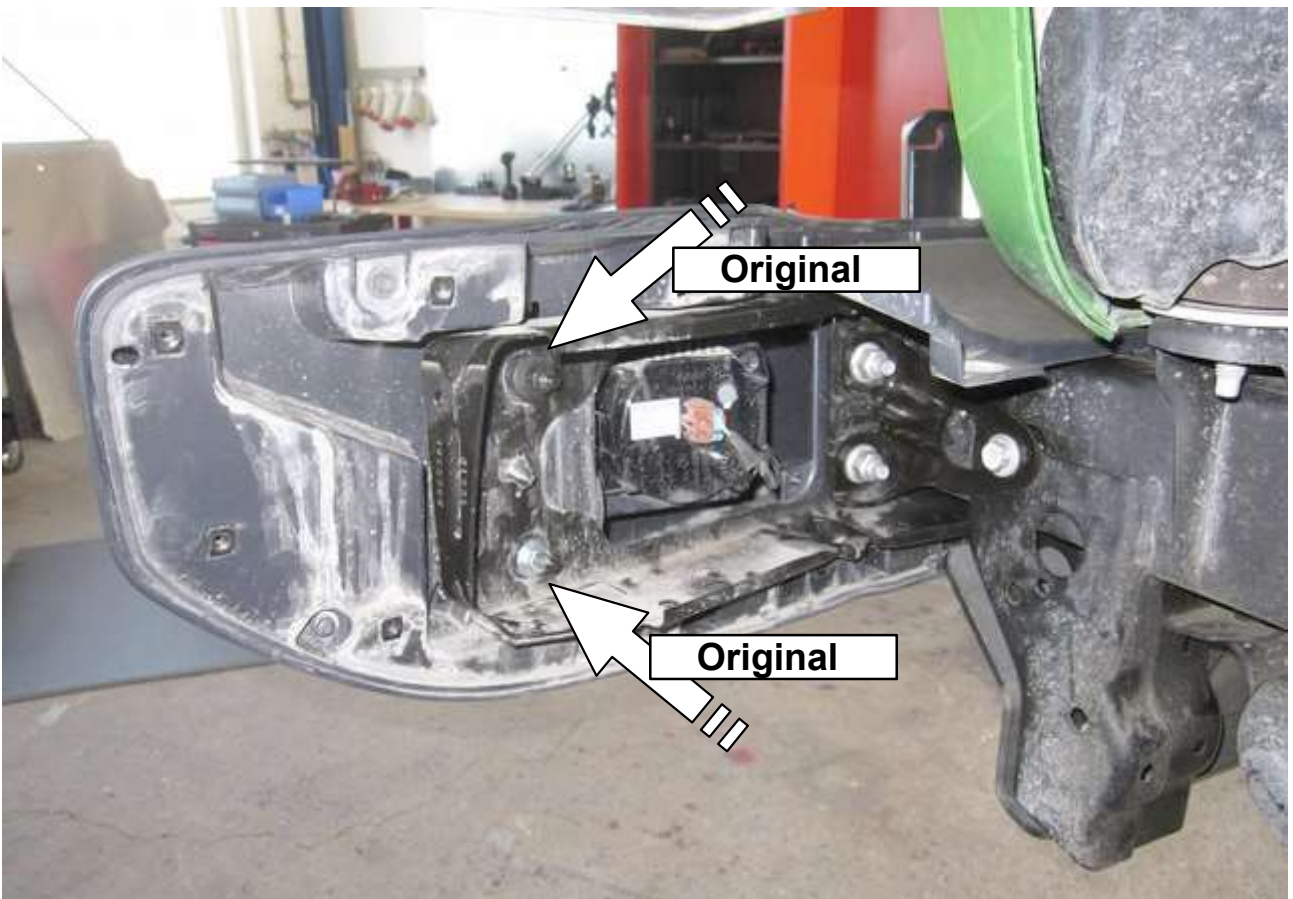

42 Das Gleiche an der rechten Seite / *The same at the right side!*

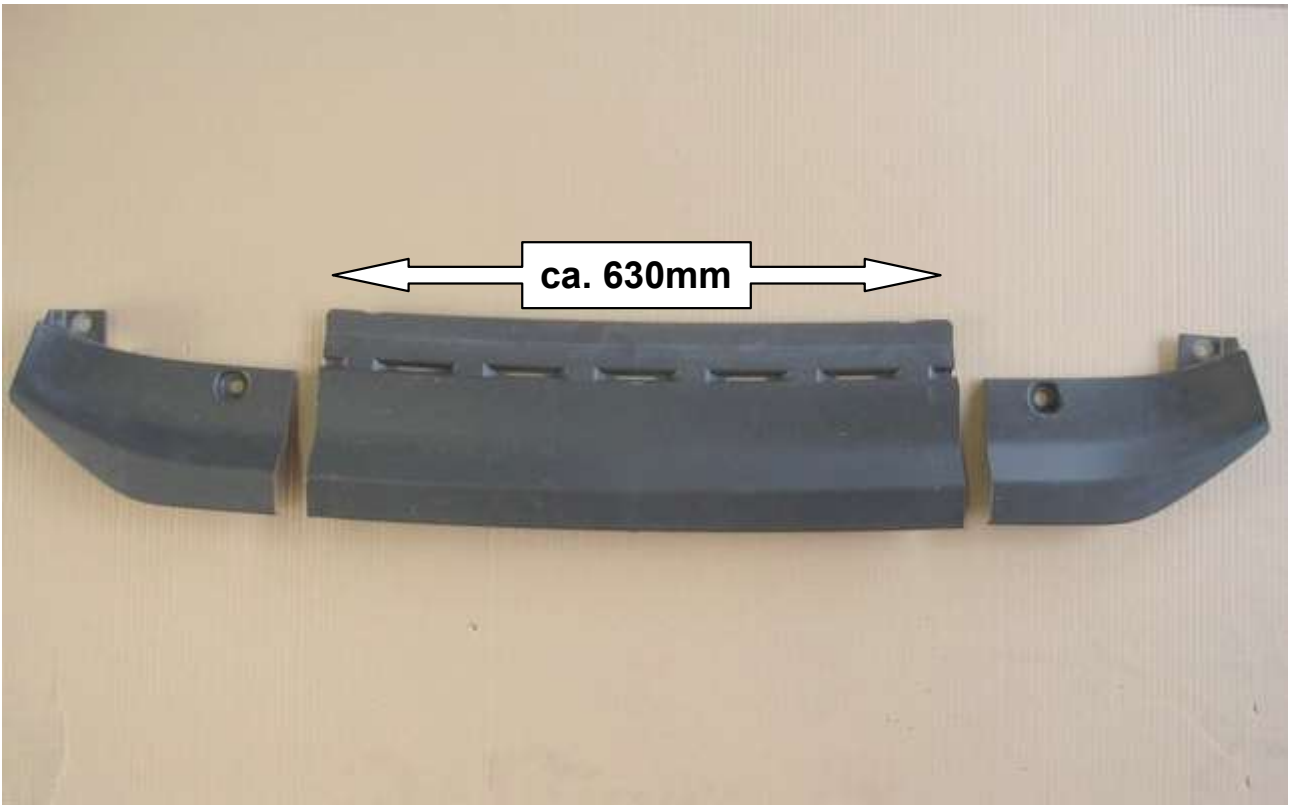

43

Zuschnitt für Zeon Winden!
Bei anderen Seilwinden muss der Zuschnitt angepasst werden.
Layout for Zeon winches only!
For other winches must it be adjusted!



44

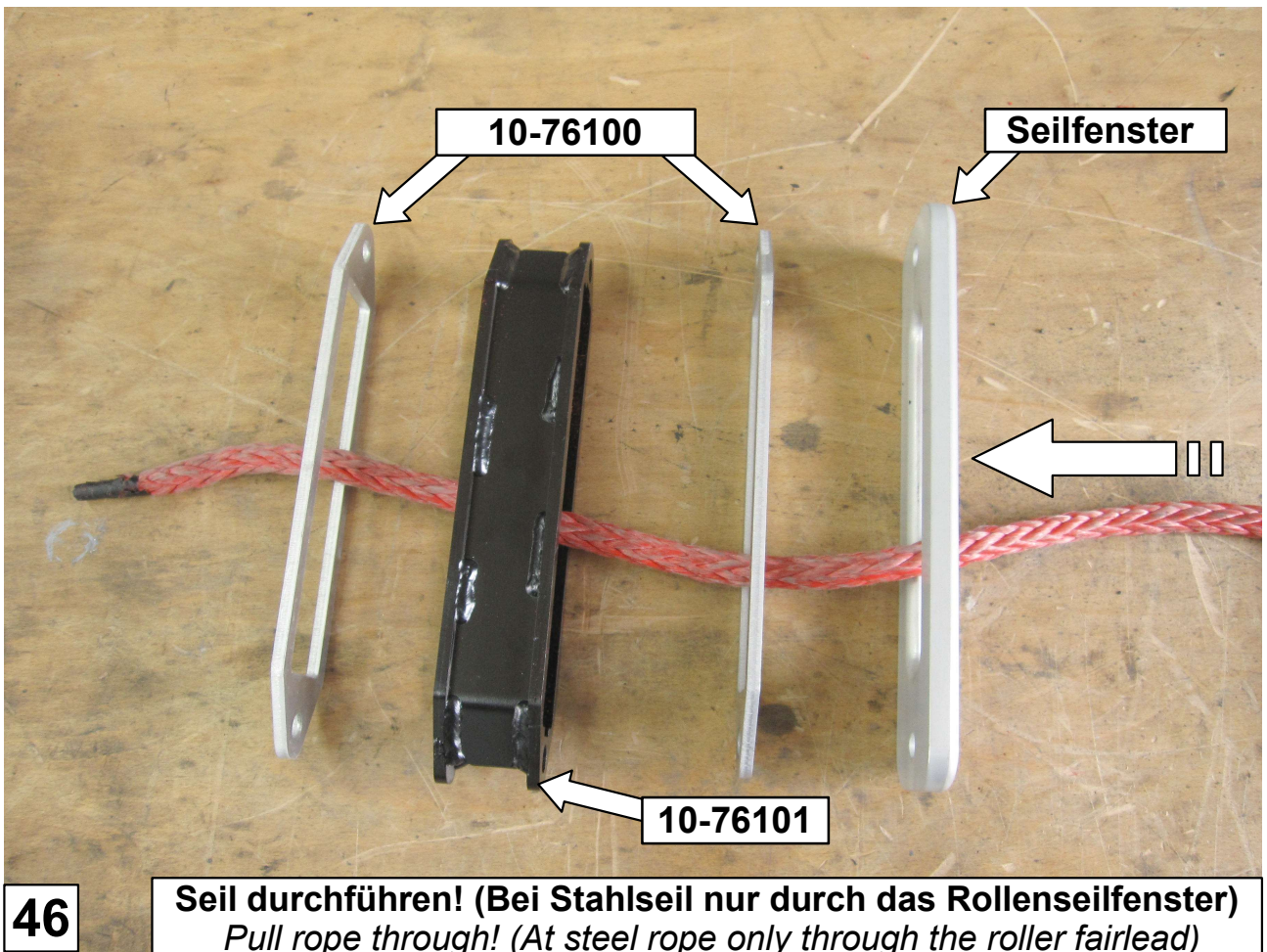



47 Bei original Warn Alu-Seilfenster entfallen die beiden Distanzen 10-76100!
 With original Warn aluminum rope window, the two distances are omitted 10-76100!

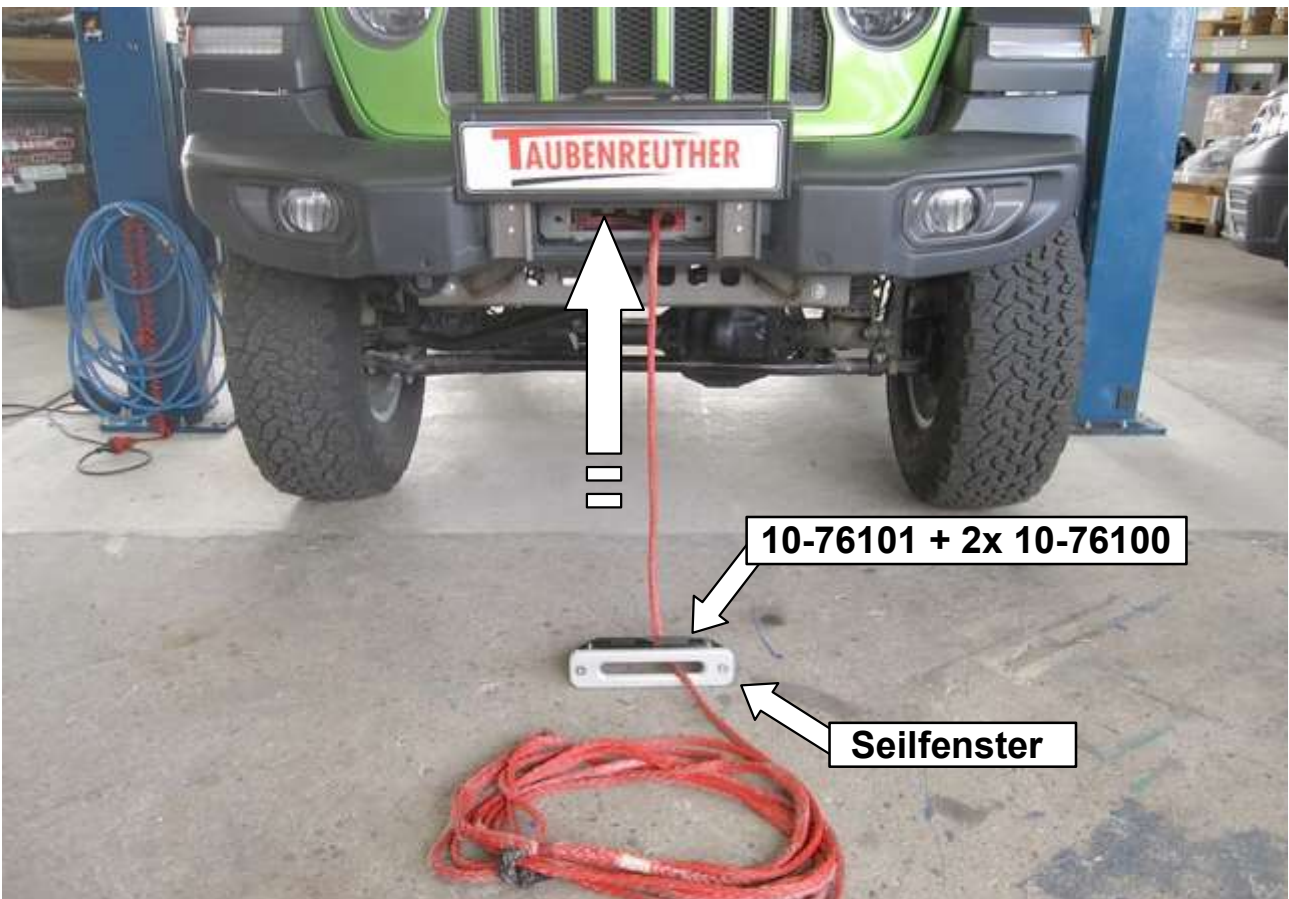

48 Seil aufspulen! / Spooling rope in!





51



52

Um den Nummerschildträger zu öffnen oder zu schließen immer gleichmäßig und mittig der Gleitschienen ziehen oder schieben!
To the license plate bar open or close, symmetrical and in centre the slides, pull or push!