

THE POWER OF

**REDARC**®

# BCDC®

## Dual Input Multi-Stage In-Vehicle Battery Charger

### MODELS:

- **BCDC1225D** 25 A
- **BCDC1240D** 40 A
- **BCDC1250D** 50 A

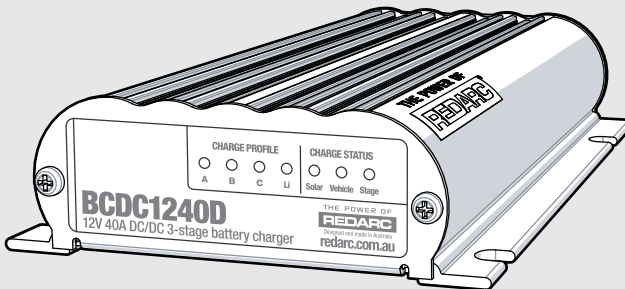

# **BCDC1225D, BCDC1240D & BCDC1250D**

## **Dual Input Multi-Stage In-Vehicle Battery Charger**

The BCDC1225D, BCDC1240D & BCDC1250D Dual Input In-vehicle Battery Chargers feature technology designed to charge your auxiliary batteries to 100%, regardless of their type or size.

The Dual Input In-vehicle Battery Chargers also feature a Maximum Power Point Tracking (MPPT) solar regulator. The unit will always take as much power from the unregulated Solar input as it can before supplementing that power, up to the maximum rated output, from Vehicle power input.

The Dual Input In-vehicle Battery Chargers are suitable for all common types of automotive lead acid batteries and LiFePO<sub>4</sub> lithium type batteries.

# CONTENTS

- WARNINGS AND SAFETY INSTRUCTIONS ..... 4**
- SPECIFICATIONS ..... 6**
- 1 PRODUCT FUNCTION ..... 7**
  - 1.1 Display Panel ..... 7
  - 1.2 Charge Profile LEDs ..... 7
  - 1.3 Charge Status LEDs ..... 8
  - 1.4 Charging Process ..... 9
  - 1.5 Soft Start Charging Process ..... 10
  - 1.6 Turn On/Off Thresholds ..... 10
  - 1.7 Error Codes ..... 11
  - 1.8 Battery Test Mode ..... 11
- 2 INSTALLATION ..... 12**
  - 2.1 Install Location ..... 12
  - 2.2 Charge Profile Selection — Orange Wire ..... 13
  - 2.3 Input Trigger Settings — Blue Wire ..... 14
  - 2.4 Cable sizing ..... 14
  - 2.5 Wiring ..... 15
  - 2.6 Fusing ..... 16
  - 2.7 Typical Setup ..... 16
  - 2.8 Connecting Solar Panels — Yellow Wire ..... 18
- 3 TROUBLESHOOTING ..... 19**
- 4 FREQUENTLY ASKED QUESTIONS ..... 21**
- 5 WARRANTY ..... 23**
- IMPORTER CONTACT INFORMATION ..... 23**

# WARNINGS AND SAFETY INSTRUCTIONS

**SAVE THESE INSTRUCTIONS** — This manual contains important safety instructions for the BCDC1225D / BCDC1240D / BCDC1250D battery charger.

Do not operate the battery charger unless you have read and understood this manual and the charger is installed as per these installation instructions. REDARC recommends that the charger be installed by a suitably qualified person.

## **⚠ WARNING**

**RISK OF EXPLOSIVE GASES:** Working in vicinity of a Lead-Acid battery is dangerous. Batteries generate explosive gases during normal operation. For this reason, it is of utmost importance that you follow the instructions when installing and using the charger.

## **SAFETY MESSAGE CONVENTIONS**

Safety messages in this manual include a signal word to indicate the level of the hazard as follows:

### **⚠ WARNING**

Indicates a potentially hazardous situation which **could result in death or serious injury to the operator or to bystanders.**

### **⚠ CAUTION**

Indicates a potentially hazardous situation which **may result in moderate or minor injury to the operator or to bystanders.**

### **NOTICE**

Indicates a situation that **may cause equipment damage.**

## **⚠ CAUTION**

1. The Battery Charger should not be used by persons (including children) with reduced physical, sensory or mental capabilities, or lack of experience and knowledge, unless they are supervised or have been instructed on how to use the appliance by a person responsible for their safety. Children should be supervised to ensure that they do not play with the Battery Charger.
2. Do NOT alter or disassemble the Battery Charger under any circumstances. All faulty units must be returned to REDARC for repair. Incorrect handling or reassembly may result in a risk of electric shock or fire and may void the unit warranty.
3. Only use the Battery Charger for charging Standard Automotive Lead Acid, Calcium Content, Gel, AGM, SLI, Deep Cycle or Lithium Iron Phosphate type 12 V batteries.
4. Check the manufacturer's data for your battery and ensure that the 'Maximum' voltage of the profile you select does not exceed the manufacturer's recommended maximum charging voltage. If the 'Maximum' voltage is too high for your battery type, please select another charging profile.
5. Check the manufacturer's data for your battery and ensure that the 'Continuous Current Rating' of the charger does not exceed the manufacturer's recommended maximum charging current.
6. When using the Battery Charger to charge a Lithium Iron Phosphate battery, only batteries that feature an inbuilt battery management system featuring inbuilt under and over voltage protection and cell balancing are suitable.
7. The Battery Charger is not intended to supply power to a low voltage electrical system other than to charge a battery.
8. Cable and fuse sizes are specified by various codes and standards which depend on the type of vehicle the Battery Charger is installed into. Selecting the wrong cable or fuse size could result in harm to the installer or user and/or damage to the Battery Charger or other equipment installed in the system. The installer is responsible for ensuring that the correct cable and fuse sizes are used when installing this Battery Charger.
9. NEVER smoke or allow a spark or flame in vicinity of battery or engine. This may cause the battery to explode.

## **PERSONAL SAFETY PRECAUTIONS**

10. To assist with the safe operation and use of the Battery Charger when connected to the battery:
  - a. Wear complete eye protection and clothing protection. Avoid touching eyes while working near a battery.
  - b. If battery acid contacts your skin or clothing, remove the affected clothing and wash the affected area of your skin immediately with soap and water. If battery acid enters your eye, immediately flood the eye with running cold water for at least 10 minutes and seek medical assistance immediately.

# SPECIFICATIONS

Part Number	BCDC1225D	BCDC1240D	BCDC1250D
Continuous Current Rating	25 A	40 A	50 A
Vehicle Input Fuse Rating	40 A (Not Supplied) REDARC FK40	60 A (Not Supplied) REDARC FK60	60 A (Not Supplied) REDARC FK60
Output Fuse Rating	recommended	recommended	recommended
Output Power	375 W	600 W	750 W
Vehicle Input Voltage Range	9 to 32 V		
Solar Input Voltage Range	9 to 32 V (unregulated only)		
Output Battery Type	Standard Lead Acid, Calcium content, Gel, AGM or LiFePO <sub>4</sub> type only		

Charging Profile	A	B	C	Li
Maximum Voltage	14.6 V	15.0 V	15.3 V	14.5 V
Float Voltage	13.3 V			13.6 V
No Load Current	<100 mA			
Standby Current	<8 mA			
Charging Temperature	Charging Profile: A/B/C Output battery > 10.5 V		-15°C to +80°C / 5°F to +176°F	
	Charging Profile: A/B/C Output Battery < 10.5 V		0°C to +80°C / 32°F to +176°F	
	Charging Profile: Li LiFePO <sub>4</sub> Output Battery		0°C to +80°C / 32°F to +176°F	
Minimum O/P Battery Volts	0.1 V			
Weight	1 kg / 2.2 lb			
Dimensions	165 × 120 × 37 mm / 6.5" × 4.75" × 1.47"			
Warranty	2 years			
Compliance Marks	RCM, E-mark, CE, UKCA			

Voltages Specified are ± 100 mV

# 1 PRODUCT FUNCTION

The BCDC1225D / BCDC1240D are three-stage, 12 V DC-DC battery chargers whereas the BCDC1250D is a four-stage, 12 V DC-DC battery charger. All BCDC Dual Input In-vehicle battery chargers operate from an alternator input of 12 V or 24 V and an unregulated 12 V nominal solar panel input.

The input voltage of the BCDC1225D / BCDC1240D / BCDC1250D can be above, below or equal to the output voltage making it ideal for charging an auxiliary 12 V battery where the distance from the main battery may cause a significant voltage drop. The BCDC1225D / BCDC1240D / BCDC1250D is also designed to isolate the main battery from the auxiliary battery, to avoid over-discharging the main battery.

## 1.1 DISPLAY PANEL

The front panel features 7 LEDs that display the Charge Profile and Charge Status.

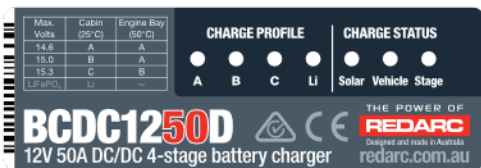
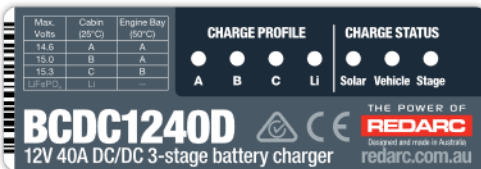
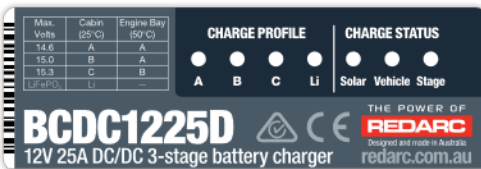

## 1.2 CHARGE PROFILE LEDs

The Dual Input In-vehicle Battery Charger features 4 different charging profiles designed to suit your battery's charging requirements. Refer to the charging specifications stated by the battery manufacturer, and the installation temperature chart before selecting the profile for your installation (see "Table 2.2.1: Charge Profile Selection").

The selected Profile LED will be on solid when the unit is ON and charging. A flashing profile LED indicates that the unit is in standby mode and NOT charging.

## 1.3 CHARGE STATUS LEDS

The Charge Status LEDs indicate to the user which inputs are available and what stage of the charge process the unit is currently in.

### 1.3.1 SOLAR AND VEHICLE LEDS

The Solar and Vehicle LEDs will be ON when the input is available and in use and OFF when the input is not available or not in use.

If both LEDs are ON, both input sources are available and in use.







The Dual Input In-vehicle Battery Charger uses Green Power Priority technology. This means the unit will always supply as much power as possible from the Solar input before supplementing this with power from the Vehicle input, to the maximum output of the unit or required by the battery at the time.

### 1.3.2 STAGE LED

The Stage LED indicates the charge profile stage. With any profile selected the BCDC1225D / BCDC1240D charger will output a 3-Stage type charging profile with Boost, Absorption and Float Stages. The BCDC1250D charger will output a 4-Stage type charging profile with Soft-Start, Boost, Absorption and Float Stages.

"Table 1.3.2.1: Charge Stage LED Sequences" outlines the LED sequences which indicate these stages, "Figure 1.4.3.1: Charging Process for BCDC1225D and BCDC1240D" on page 9 explains the Charging Process and "Figure 1.5.3.1: Soft Start Charging Process for BCDC1250D" on page 10 explains the Soft Start Charging Process.

**Table 1.3.2.1:** Charge Stage LED Sequences

LED Flash Sequence		Profile Stage
Continuous		OFF / No Output
2 Seconds		ON, With No Output
2 Seconds		Soft-Start (BCDC1250D only)
Continuous		Boost (Constant Current)
2 Seconds		Absorption (Constant Voltage)
2 Seconds		Float

### 1.3.3 OPTIONAL EXTERNAL LED

To provide charge status and error feedback away from the main unit, a standard 12 V LED (with integrated resistor) can be wired as shown in [Figure 2.7.1.1](#) and [Figure 2.7.2.1 on page 17](#).

If used, this external LED is either OFF (BCDC not charging), ON (BCDC charging) or FLASHING (see "Error Codes" on page 11). A standard 3 V LED (no integrated resistor) will not operate correctly if installed.



## 1.4 CHARGING PROCESS

### BOOST

When the Charger is turned on, it will begin in the Boost stage. The Boost stage maintains a constant current until the battery voltage reaches its Absorption Voltage. The current in Boost stage may vary during operation in order to maintain safe operating temperature, or to limit the difference between input and output voltages.

### ABSORPTION

The Charger will then move to Absorption stage which maintains a constant voltage level for a predetermined period of time or until the current being drawn by the output battery drops to less than 4 A for 30 seconds; after which the Charger will enter Float stage.

### FLOAT

Float stage maintains 13.3 V (13.6 V for LiFePO<sub>4</sub>) on the output battery, keeping the battery topped up. This counteracts the battery's self discharging or loads applied to the battery. When the battery loses charge, the Charger will move back into the Boost stage.

**Figure 1.4.3.1:** Charging Process for BCDC1225D and BCDC1240D

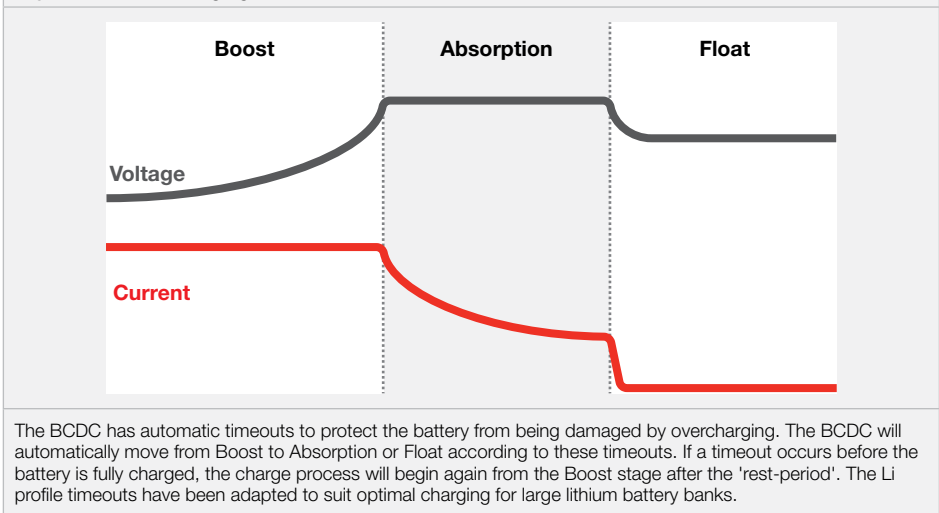

## 1.5 SOFT START CHARGING PROCESS

### SOFT-START

When the Charger is turned on, it will start ramping current from 0 A up to the full rated current, this is called Soft-Start and usually takes around 30 seconds. Once the full rated current is reached the charger will move into Boost stage. The soft start charging process only applies to the BCDC1250D.

**Figure 1.5.3.1:** Soft Start Charging Process for BCDC1250D

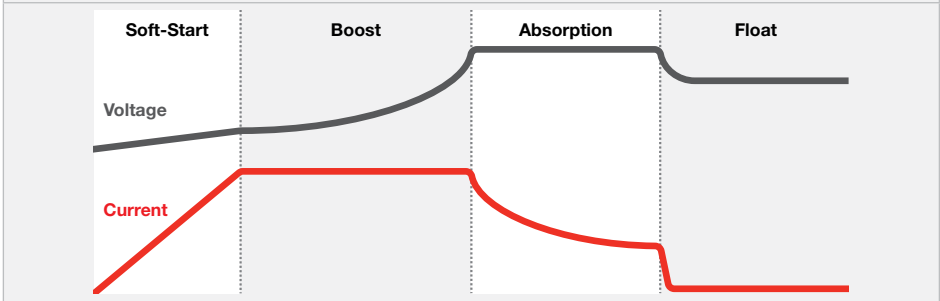

## 1.6 TURN ON/OFF THRESHOLDS

**Table 1.6.1:** Turn On/Off Thresholds

	Input	12 V Vehicle Input		24 V Vehicle Input		Solar
		Standard	Low Voltage	Standard	Low Voltage	
	Input Trigger Settings	Standard	Low Voltage	Standard	Low Voltage	N/A
<b>Input Open Circuit Low voltage conditions</b> *1	Turn ON ABOVE	12.9 V	12.0 V	25.8 V	24.0 V	9.0 V
	Turn OFF BELOW	12.7 V	11.9 V	25.4 V	23.8 V	9.0 V
<b>Input Loaded Low voltage conditions</b> *2	Stop Charging BELOW	12.2 V	11.3 V	24.4 V	22.6 V	N/A
	Turn OFF instantly BELOW	8.0 V		8.0 V		9.0 V
	Turn OFF after 20 s BELOW	9.0 V		9.0 V		N/A
<b>Input Overvoltage shutdown</b>	Turn ON BELOW	15.5 V		32.0 V		32.0 V
	Turn OFF instantly ABOVE	16.0 V		32.5 V		33.0 V
	Turn OFF after 20 s ABOVE	15.6 V		32.1 V		N/A
<b>Output Undervoltage shutdown</b> *1	Shutdown if Output Battery < 0 V					

\*1 Tested every 100 seconds | \*2 Tested constantly

There is a maximum 20 second delay before the charger will produce an output any time a source is introduced into the system, this allows the unit to provide optimum input sharing and effective battery isolation.

## 1.7 ERROR CODES

In the event of a fault with the unit installation, either battery or solar panel, ALL the LEDs on the unit will flash to indicate the fault type.

LED State	Description
1 flash (followed by 3.5 second off)	Internal hardware fault
2 flash (followed by 3.5 second off)	Unit under temp fault
3 flash (followed by 3.5 second off)	Unit over temp fault
4 flash (followed by 3.5 second off)	Output battery fault (Volts too high)
5 flash (followed by 3.5 second off)	Input under voltage (Battery) <sup>*3</sup>
6 flash (followed by 3.5 second off)	Input over voltage (Battery or Solar panel)

\*3 If the unit is being supplied power from the vehicle and solar simultaneously and ONE of those sources is undervoltage, that specific source LED will flash 5 times. If the unit is being supplied power from the vehicle and solar with BOTH sources under voltage, OR if the unit is being supplied power from one input only and that input is undervoltage, ALL LED's will flash 5 times.

## 1.8 BATTERY TEST MODE

The unit features a battery test mode which occurs every 100 seconds. The test mode is designed to both test that the input conditions are still met and check for the presence of a battery on the output of the unit. This feature is designed to protect the vehicle battery from over discharge and protect the vehicle and wiring in the event of damage to the output connection. During low output current situations (when in Float mode for example) this battery test may take up to 60 seconds to complete.

## 2 INSTALLATION

**NOTE:** The REDARC BCDC Series In-Vehicle chargers are suitable for use on vehicles with conventional alternator charging systems, including standard, variable voltage and idle stop type alternators.

### 2.1 INSTALL LOCATION

The REDARC BCDC Mounting Bracket Series is available to suit a range of common vehicles. The brackets attach to pre-existing mounting points on the vehicle to facilitate installation of the BCDC, minimising the need for vehicle modification.

#### ⚠ CAUTION

The heatsink can reach around 60°C / 140°F (this is normal and safe operation when the unit deliver full power or run in hot conditions). The location to install the unit should prevent contact with the users of the vehicle and not be in contact with highly flammable material.

The unit will operate optimally below 55°C / 130°F with good airflow. At higher temperatures the unit will de-rate output current up to 80°C / 175°F at which point the unit will turn OFF.

The charger is suitable for mounting in the cabin of the vehicle, along a chassis rail or in the engine bay (ensure the unit does not become covered by a build up of mud or other). If mounting in an engine bay, locate the unit away from high temperature areas for maximum performance.

Choose locations such as on the inner guard, behind a headlight or behind the grille to one side of the radiator.

REDARC recommend keeping the cable length between the charger and auxiliary battery to less than 1 m. It is important to ensure the charger is mounted as close as possible to the battery being charged (auxiliary battery). Certain batteries are better suited to each of these types of installations so it is important to select the correct battery type. For more information consult your battery manufacturer's specifications. For example, most of the lithium type (LiFePO<sub>4</sub>) batteries are not suitable for engine bay installations. Refer to "[Charge Profile Selection](#)" on page 13 to select the best Charge Profile for your installation.

The charger should be mounted in any orientation (so that the front decal is visible) using the 4 mounting tabs provided on the heatsink using suitably sized screws.

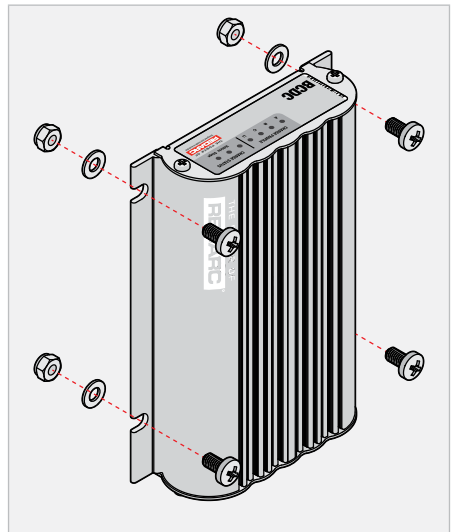

## 2.2 CHARGE PROFILE SELECTION – ORANGE WIRE

Connect the ORANGE wire to set the Maximum output voltage to suit your selected Charge Profile. Refer to "Table 2.2.1: Charge Profile Selection" to select the correct profile for your installation configuration (Cabin Install or Engine Bay Install).

Maximum Battery Voltage Specification	Auxiliary Battery Location	
	Cabin Install (25°C / 75°F)	Engine Bay Install (50°C / 120°F)
14.6	A	A
15.0	B	A
15.3	C	B
14.5 (LiFePO <sub>4</sub> )	Li	Not Recommended

### ⚠ CAUTION

Check the manufacturer's data for your battery and ensure that the Maximum voltage of the Charging Profile you select does not exceed the manufacturer's recommended maximum charging voltage. If the Maximum voltage is too high for your battery type, select another Charging Profile.

When using the Battery Charger to charge a Lithium Iron Phosphate (LiFePO<sub>4</sub>) battery, only batteries with an inbuilt battery management system with under and over voltage protection and cell balancing are suitable.

**Figure 2.2.2:** Setting the Maximum Voltage (ORANGE wire)

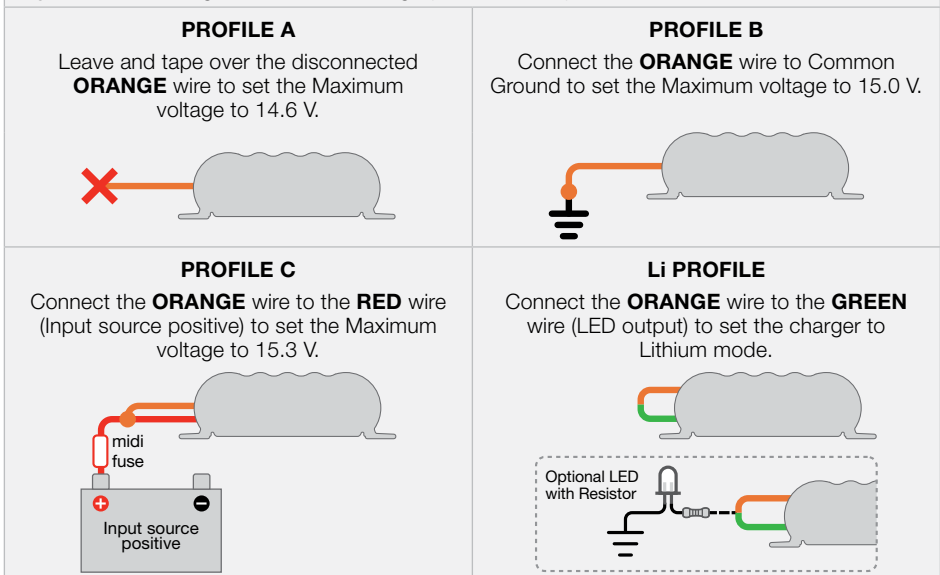

## 2.3 INPUT TRIGGER SETTINGS – BLUE WIRE

Connect the BLUE wire to switch the vehicle input turn-ON-trigger mode between:

- Standard Trigger (for fixed voltage or temperature compensating alternators)
- Low Voltage Trigger (for variable voltage alternators)

**Figure 2.3.1:** Connecting the BLUE wire

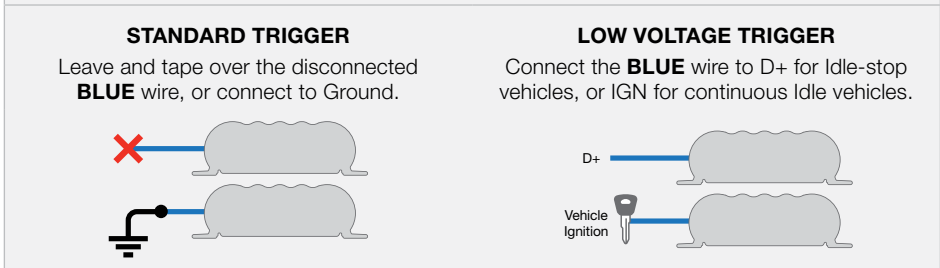

**Table 2.3.2:** Setting the Input Trigger Settings<sup>\*1</sup>

Input Mode	Blue Wire Connection	12 V Mode		24 V Mode	
		ON above	OFF below	ON above	OFF below
<b>Standard</b>	Not Connected, or Connected to Ground	12.9 V	12.7 V	25.8 V	25.4 V
<b>Low Voltage</b>	D+ for Idle-Stop 'Ignition' for others	12.0 V	11.9 V	24.0 V	23.8 V

\*1 Tested every 100 seconds

## 2.4 CABLE SIZING

Refer to "[Table 2.4.1: Cable Sizing](#)" for the Vehicle Input, Solar Input, Ground and Battery Output cable thickness and length requirements. Always choose a wire cross sectional area equal to or greater than what is specified.

**NOTE:** For optimum performance, ensure the BROWN wire is at maximum 1m (3.9') in cable length from the battery charger and for safety considerations, mount the MIDI fuse in close proximity of the auxiliary battery.

**Table 2.4.1:** Cable Sizing

Part Number	Cable Install Length		Wire Cross Sectional Area	Nearest Equivalent BAE, B&S, AWG
<b>BCDC1225D</b>	1 – 5 m	3' – 16'	≥ 7.71 mm <sup>2</sup>	8
	5 – 9 m	16' – 30'	≥ 13.56 mm <sup>2</sup>	6
<b>BCDC1240D</b>	1 – 5 m	3' – 16'	≥ 13.56 mm <sup>2</sup>	6
<b>BCDC1250D</b>	5 – 9 m	16' – 30'	≥ 20.28 mm <sup>2</sup>	4

## ⚠ CAUTION

Cable and fuse sizes are specified by various codes and standards which depend on the type of vehicle the Battery Charger is installed into. Selecting the wrong cable or fuse size could result in harm to the installer or user and/or damage to the Battery Charger or other equipment installed in the system. The installer is responsible for ensuring that the correct cable and fuse sizes are used when installing this Battery Charger.

Cabling is recommended to be away from heat sources and in protected areas, especially when installing or routing in the engine bay.

## 2.5 WIRING

The heavy gauge wires on the BCDC1225D / BCDC1240D / BCDC1250D unit carry peak currents of up to 55 A and it is important to make a good, low resistance electrical connection that will not degrade over time. Failure to make a good reliable contact may result in breakdown of the wire insulation and cause a short circuit, or worst case a fire. We recommend that this activity be undertaken by an appropriately trained person.

REDARC recommends using a soldered butt splice crimp connection (see "[Figure 2.5.1: Ensuring a good wiring connection](#)") that is covered with heatshrink. REDARC does not recommend using standard red/blue/yellow blade connections, as they are not rated for either the current required or gauge of wire supplied on the unit.

Crimping provides good mechanical connection, soldering provides a long lasting electrical connection and forming of the heatshrink will prevent any shorting/contact with your vehicle chassis.

**Figure 2.5.1:** Ensuring a good wiring connection

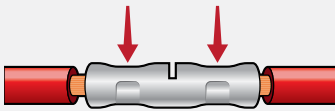

**Crimp** both wires to the butt splice using single-indent type crimpers. Fold the cable over before inserting into the butt-splice as required. Single-indent crimpers should also be used on any lugs used.

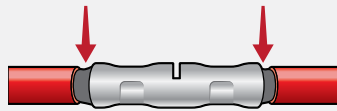

**Solder** the wires to the butt splice. Ensure that a good connection is made. Keep heatshrink away until after soldering is complete and has cooled.

## 2.6 FUSING

REDARC recommends using MIDI style bolt down fuses as they ensure a low resistance connection. The REDARC FK40 and FK60 fuse kits are recommended.

Blade type fuses are not recommended as they can result in a high resistance connection which causes excess heat and may damage the fuse holder and/ or the wiring. Self-resetting circuit breakers are not recommended as they may trip prematurely due to the heat generated by the current flowing through the wires.

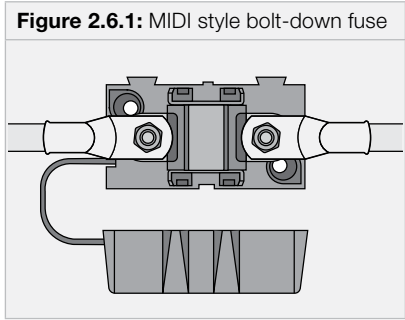

**Figure 2.6.1:** MIDI style bolt-down fuse

## 2.7 TYPICAL SETUP

REDARC recommends that the charger be installed by a suitably qualified person.

Refer to "[Table 2.4.1: Cable Sizing](#)" for the Vehicle Input, Solar Input, Ground and Battery Output cable thickness and length requirements.

### 2.7.1 LEAD ACID BATTERY SETUP

**Figure 2.7.1.1:** Typical Lead Acid Battery Setup (12 V or 24 V and Solar)

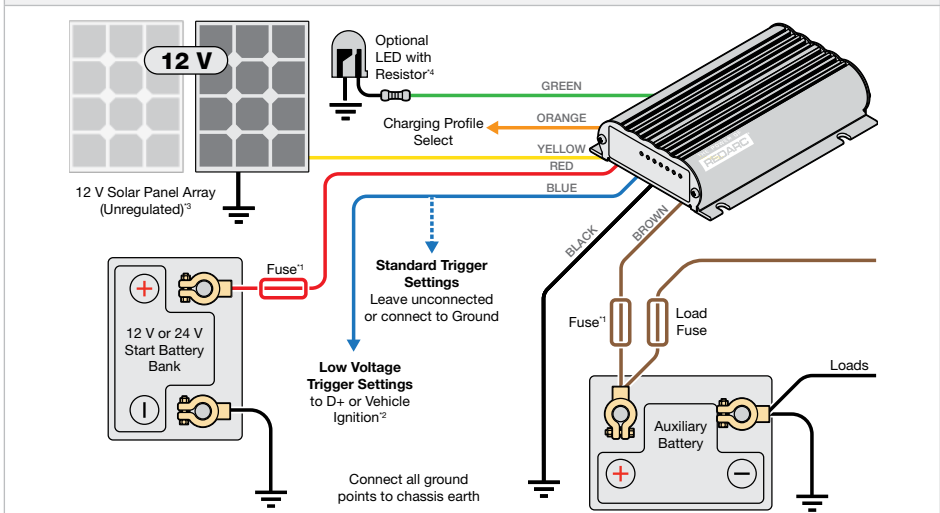

\*1 Fuse Ratings to be as per the table in "[Specifications](#)" on page 6. Fuses should be mounted as close as possible to the battery terminal.

\*2 To connect the Blue wire to the vehicle's ignition, connect the Blue wire to an ignition switched fuse in one of the vehicles fuse boxes, located in either the engine compartment or vehicle cabin.

\*3 Do not connect regulated solar panels. If solar is not connected, tape over unused wires.

\*4 If using an Optional LED, use a standard 12V LED with an integrated resistor (12 V = 1 k $\Omega$  or 24 V = 2.2 k $\Omega$ ). A basic 3V LED will not operate correctly if installed.



## 2.7.2 LiFePO<sub>4</sub> SETUP

**Figure 2.7.2.1:** Typical LiFePO<sub>4</sub> Setup (12 V or 24 V and Solar)

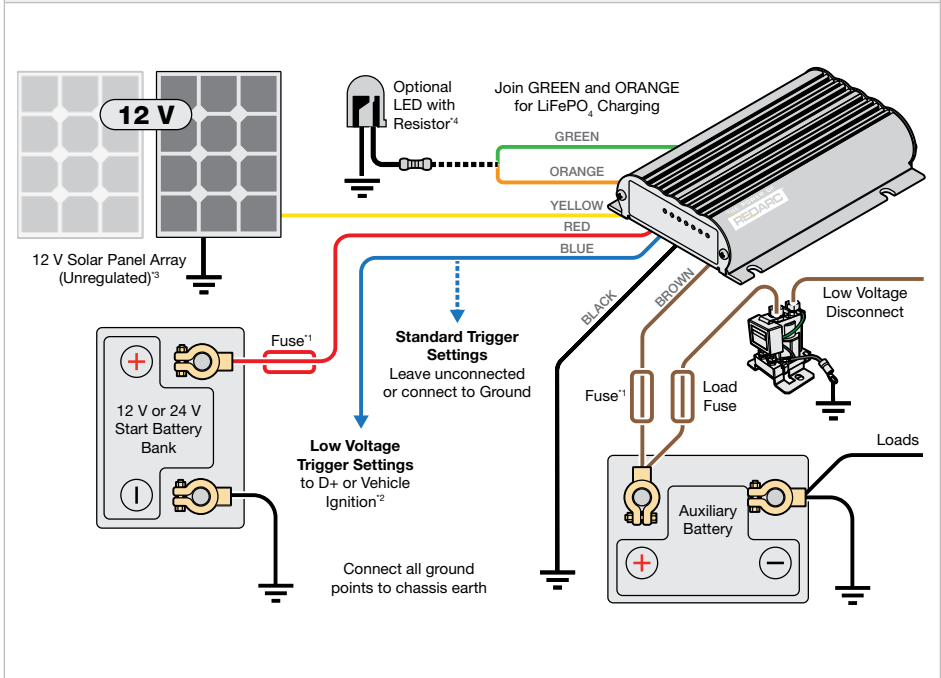

\*1 Fuse Ratings to be as per the table in "Specifications" on page 6. Fuses should be mounted as close as possible to the battery terminal.

\*2 To connect the Blue wire to the vehicle's ignition, connect the Blue wire to an ignition switched fuse in one of the vehicles fuse boxes, located in either the engine compartment or vehicle cabin.

\*3 Do not connect regulated solar panels. If solar is not connected, tape over unused wires.

\*4 If using an Optional LED, use a standard 12V LED with an integrated resistor (12V = 1 kΩ or 24V = 2.2 kΩ). A basic 3V LED will not operate correctly if installed.

## 2.8 CONNECTING SOLAR PANELS – YELLOW WIRE

The optional YELLOW wire connects solar input to the BCDC. If solar is not installed, tape over the unused wires.

DO NOT connect solar panels that have inbuilt regulators. The BCDC has an inbuilt regulator that may not function correctly if regulated solar panels are connected.

### 2.8.1 CONNECTING MULTIPLE SOLAR PANELS

There is no limitation of how many solar panels you can connect in parallel to your BCDC but you will need to size the cables correctly (refer to "Table 2.4.1: Cable Sizing" on page 14).

The BCDC will automatically limit the Power going to the unit if the panels supply more than the maximum needed. (375 W for BCDC1225D, 600W for BCDC1240D, 750W for BCDC1250D). Power generated by solar panels is affected by light level, cloud cover and time of day, so having additional solar panels can still be beneficial for charging in sub-optimal conditions.

**NOTE:** Most house panels have an open circuit voltage with a 32 V limit, the BCDC is not suitable for these panels.

### CONNECTING SOLAR PANELS IN PARALLEL

**NOTE:** Do not connect solar panels in series, when connecting multiple 12 V solar panels, it is important to connect them in parallel. Connecting in parallel ensures the output voltage remains the same while doubling the overall power output of the array.

**Figure 2.8.1.1:** Connecting solar panels in parallel

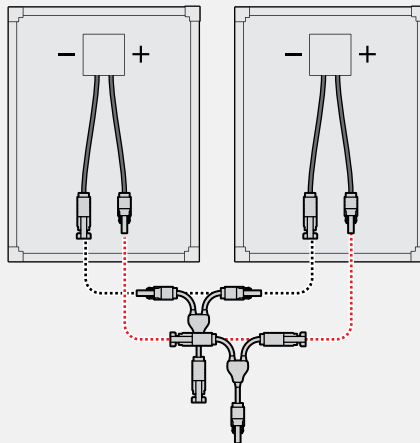

Example only, panels/configurations may vary.

# 3 TROUBLESHOOTING

## **There are no LEDs ON at all.**

This indicates that there is no battery connected to the output (BROWN wire) or that battery is not at a suitable voltage level to be charged AND the input (YELLOW/RED wire) of the charger is not connected.

1. Check all wiring to the charger and battery, particularly the Ground (BLACK wire).
2. Check fuses are intact and properly connected.

If the problem persists, contact your local Auto-Electrician.

## **The Charge Profile LED is flashing.**

This indicates that either Output or Input is not valid, either:

- An Auxiliary battery at a suitable voltage level to be charged is connected to the output of the charger, however there is currently no valid charging source.
  - A valid charging source is available but the Auxiliary battery is not at a suitable voltage level to be charged or is not connected.
1. Check that the Vehicle (RED wire) and/or Solar (YELLOW wire) are electrically connected.
    - The Vehicle (RED wire) should connect directly to the Vehicle battery positive terminal via an adequately rated fuse.
    - The Solar (YELLOW wire) should connect directly to the Solar Panel positive terminal/wire.
  2. Check that the Ground (BLACK wire) is connected to the Auxiliary battery and Chassis Earth and/or the Solar Panel negative terminal/wire.
  3. Check all wiring to the Auxiliary battery, particularly the Ground (BLACK wire).
  4. Check fuses are intact and properly connected.

If the problem persists, see the relevant points following.

**I have Solar connected but the Solar LED is OFF.**

This indicates that the required turn ON conditions for this source have not been met. Either the Open Circuit Voltage at the YELLOW wire on the charger is below 9 V or there is not sufficient power available from the Solar Panel (due to poor light conditions or a faulty panel).

1. Is the sun out? No or low sunlight levels mean low power to your solar panels.
2. Check that the solar panel is not being shaded (by a tree etc.).
3. Check the voltage at the YELLOW wire, as close as possible to the charger, is above 9 V.
4. Check all wiring to the Solar Panel, particularly the Ground (BLACK wire).
5. Ensure you have an unregulated solar panel.

Allow up to 2 minutes after any change for the unit to recognise the input, if the problem persists, contact your local Auto-Electrician.

**The BCDC is connected to the Vehicle but the Vehicle LED is OFF.**

This indicates that the required turn ON conditions for this source have not been met OR the Solar input is supplying the full input power requirements of the charger.

With the BLUE wire left unconnected, the voltage at the RED wire must be above 12.9 V for a 12 V installation or above 25.8 V for a 24 V installation.

With the BLUE wire connected to Ignition, Ignition must be on and the voltage at the RED wire must be above 12.0 V for a 12 V installation or above 24.0 V for a 24 V installation.

1. Check that the vehicle is running.
2. Check the voltage on the RED wire is above the required turn ON threshold for your installation. (See "[Table 1.6.1: Turn On/Off Thresholds](#)" on page 10).
3. Check all wiring to the Vehicle battery, particularly the Ground wire (BLACK).

If the problem persists, contact your local Auto-Electrician.

## 4 FREQUENTLY ASKED QUESTIONS

### **The BCDC Dual Input turns ON at 12.9 V (12 V) and OFF at 12.7 V (11.9 V), but you say it operates down to 9 V, please explain?**

The BCDC Dual Input will turn OFF for a split second every 100 seconds to measure the unloaded voltage at the battery. When the BCDC Dual Input turns off, it is not drawing any load from the start battery. No load means that there is no voltage drop over the cable run. This allows the BCDC Dual Input to measure the actual battery voltage, or the voltage at the battery. If this actual battery voltage is below 12.7 V (11.9 V), the BCDC Dual Input will turn OFF. At any other time during the charging process if the voltage at the BCDC Dual Input drops below 9 V, the BCDC Dual Input will turn OFF.

### **How does the BCDC Dual Input charge an Auxiliary battery at 14 V when it only gets 9 V in?**

The BCDC Dual Input can act as both a reducer and a booster, so it can operate from a voltage of above, equal to or below the desired output voltage. The unit is also microprocessor controlled allowing it to output a REDARC proprietary charging algorithm independent of the input. This allows the unit to charge specific to the battery type even if the input voltage is low due to voltage drop.

### **Where should I mount the BCDC Dual Input Unit?**

The BCDC Dual Input should be mounted as close as possible to the battery being charged (generally called the Auxiliary or House battery). If the Auxiliary battery is located under the bonnet, pick a location for the BCDC Dual Input that is close to the battery and away from any direct engine heat. If the BCDC Dual Input is to be mounted into a Caravan or Camper, near or in the battery compartment is generally the best position. It is also a good idea to mount the BCDC Dual Input to a metal surface if possible to ensure optimal heat dissipation, though this is not crucial.

### **What does the charger do if the temperature around it rises above its operating temperature?**

As the temperature of the BCDC Dual Input rises above a certain level the current capacity of the output is decreased gradually in order protect both the battery and the BCDC Dual Input unit.

### **If I use the BCDC Dual Input to charge my auxiliary battery do I still need to install a battery isolator?**

The BCDC Dual Input incorporates the functionality of a battery isolator, it will turn ON and start charging when it senses that the vehicle has started and similarly it will turn OFF when the vehicle is turned OFF.

**I've heard that you shouldn't charge 2 batteries of different chemistries from the same source, will I have any problems charging my AGM or Gel auxiliary battery from my Lead Acid start battery?**

The BCDC Dual Input does not 'link' the batteries together like a battery isolator does, it is a DC-DC battery charger. The output from the unit is tailored specifically to the selected output battery type, and therefore allows the optimal charging of the auxiliary battery, no matter what chemistry your start battery is.

**My BCDC Dual Input is setup for 12 V Alternator input but will not start when the vehicle is turned On, I've followed the trouble shooting guide and the setup is fine, what's the problem?**

The most likely cause of this issue is that the BCDC Dual Input is somehow stuck in 24 V mode. Try removing the Vehicle wire (RED) and reconnecting it. If the problem persists, contact REDARC. Alternatively, the input voltage may be too low, check that the input voltage is above the input thresholds outlined in ["1.6 Turn On/Off Thresholds" on page 10](#).

**Can the BCDC Dual Input charge from Solar and Vehicle power at the same time?**

Yes. The BCDC Dual Input will always attempt to supply power from the Solar source first (when available) and will supplement this input with power from the Vehicle source (when available).

**Can the BCDC Dual Input operate with only a single power source input?**

Yes. The BCDC Dual Input will operate as a stand-alone solar regulator when only Solar (YELLOW wire) is connected or it will operate as a DC charger when only the Vehicle (RED wire) is connected.

# 5 WARRANTY

## LIMITED WARRANTY

For full warranty terms and conditions, visit the Warranty page of the REDARC website. Refer to the web address and contact details applicable to your region.

### Australia, New Zealand & Europe

[www.redarc.com.au/warranty](http://www.redarc.com.au/warranty)

REDARC Electronics Pty Ltd  
23 Brodie Road (North),  
Lonsdale SA 5160  
Australia

**Australia** +61 8 8322 4848  
**New Zealand** +64-9-222-1024  
**UK & Europe** +44 (0)20 3930 8109

### North America

[www.redarcelectronics.com/warranty](http://www.redarcelectronics.com/warranty)

REDARC Corporation  
c/o Shallco, Inc.  
308 Component Dr.  
Smithfield, NC 27577  
USA

**USA** +1 (704) 247-5150  
**Canada** +1 (604) 260-5512  
**Mexico** +52 (558) 526-2898

## CHECKING THE SERIAL NUMBER

The Product Serial Number is located on the Main Unit and on the product packaging.

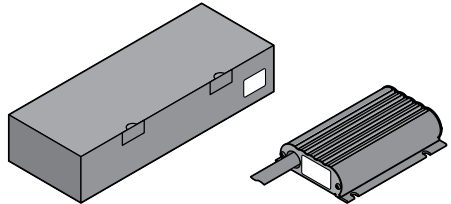

## IMPORTER CONTACT INFORMATION

### UK

Ozparts UK Ltd  
1 Prospect Place  
Pride Park  
DE24 8HG, Derby  
UK

### Europe

Ozparts Pl sp. z o. o.  
ul. Slowackiego 32/5  
87-100 Torun  
Poland

 REDARC Electronics Pty Ltd  
23 Brodie Road (North), Lonsdale South Australia 5160, Australia

Design and specifications are subject to change without notice | Copyright © REDARC Electronics Pty Ltd. All rights reserved  
REDARC®, THE POWER OF REDARC®, and BCDC® are trademarks of REDARC Electronics Pty Ltd.

**Tech Support**

1300 REDARC

**Head Office**

+61 8 8322 4848

**New Zealand**

+64 9 222 1024

**UK & Europe**

+44 (0)20 3930 8109

**USA**

+1 (704) 247 5150

**Canada**

+1 (604) 260 5512

**Mexico**

+52 (558) 526-2898

**redarcelectronics.com**

THE POWER OF

**REDARC**<sup>®</sup>